



Manufacturing & Distributing Optical Supplies Since 1996

2019-2020
CATALOG
NEW PRICES
EFFECTIVE
AUGUST 2019

Innovative Products and Solutions to Help Grow Your Business



Exam Supplies • Cleaners & Cloths • Accessories • Sun Lenses • Frame Parts • Tools • Machines • Finishing • Surfacing

dynamiclabs.net

888-339-6264

Intl. 631-231-7474

Manufacturing and Distributing Optical Supplies Since 1996

Dynamic Labs has been serving the optical community for over 20 years. Our goal of being a service minded vendor has helped us to grow along with our customers. We offer one-on-one, personalized service that enables us to learn how to best serve your business. We make it our goal to understand your business and help you be more productive and profitable.

We are not just a distributor. We are an independently American owned manufacturer. We manufacture most of our core products in our New York facility, a few miles from where we grew up. Many of our best selling items were developed in direct response to the specific needs and desires of our customers.

Dynamic labs has grown to be a true full service supplier to independent retail stores, retails chains and wholesale labs. This enables our customers to consolidate their purchasing with one representative at one company; who can work directly with them to be more profitable and productive.

Some of our core product lines are:

Purity® and Ultra Vue® Lens Cleaners and Cloths – Many of these lines are certified by Colts Laboratories and can be personalized for you. When you personalize products it is your name on them, so it is important to us to make sure that they are the finest quality available.

HD Silicone® Nosepads – Our line of dispensary items are anchored by our HD silicone nose pads. These pads are made from our proprietary high density silicone which makes them more resistant to discoloration but remains soft and comfortable.

ProGRIP® Combo Blocking Pad – As lens coatings and materials have become more difficult to edge over the years, we have developed a variety of different blocking pads to solve a myriad of edging problems. The **ProGRIP combo pad** combines the award winning **DynaGrip Xtreme® Anti-Slip Disc** with a blocking pad to make the ultimate “One Step Solution”. This pad not only eliminates slipping but greatly reduces twisting as well.

ZEISS Brand and Eclipse Sunglass Lenses – Throughout the years, optical practices have often asked us for new concepts and products that can add revenue to their existing shop. Dynamic Labs has pioneered the concept of expanding an optical practice by becoming a custom sunglass store as well. The results have been extraordinary!

Surfacing Pads and Supplies – Conventional and Digital surfacing is as much an art as it is a science. Let us work with you to come up with the proper solutions to your surfacing needs.

In this catalog we have greatly expanded our offering. We have added hundreds of new items to our line. Please take the time and look through this expanded catalog and let us know what you think.

We look forward to hearing from you.

David Beauchamp, CEO & President

Steven Zwerman, COO & VP



Your Invitation Is Waiting

Dynamic Labs would like to invite you to participate in our program specifically designed for customers just like you!

We are grateful for your loyalty to Dynamic Labs and we would like to offer an additional automatic two percent discount (above and beyond any discount currently offered on our products) to those who join this program!

Your credit card information will be kept on file in our offices, encrypted and in a secure environment. When you place an order, your card will be charged only for the merchandise that is shipped, on the day that it is shipped.

Additionally, every now and then, we will offer exclusive promotions and savings on both new and popular products to members of our Preferred Customer Program as our way of saying "Thank You!" for purchasing from Dynamic Labs.

Please consider joining this select group of customers today.

Visit: dynamiclabs.net and click on Preferred Customer Program to fill out an online application. You may also call one of our representatives for an application.

dynamiclabs.net

Optical Supplies Available to You, Whenever, Wherever You Are!

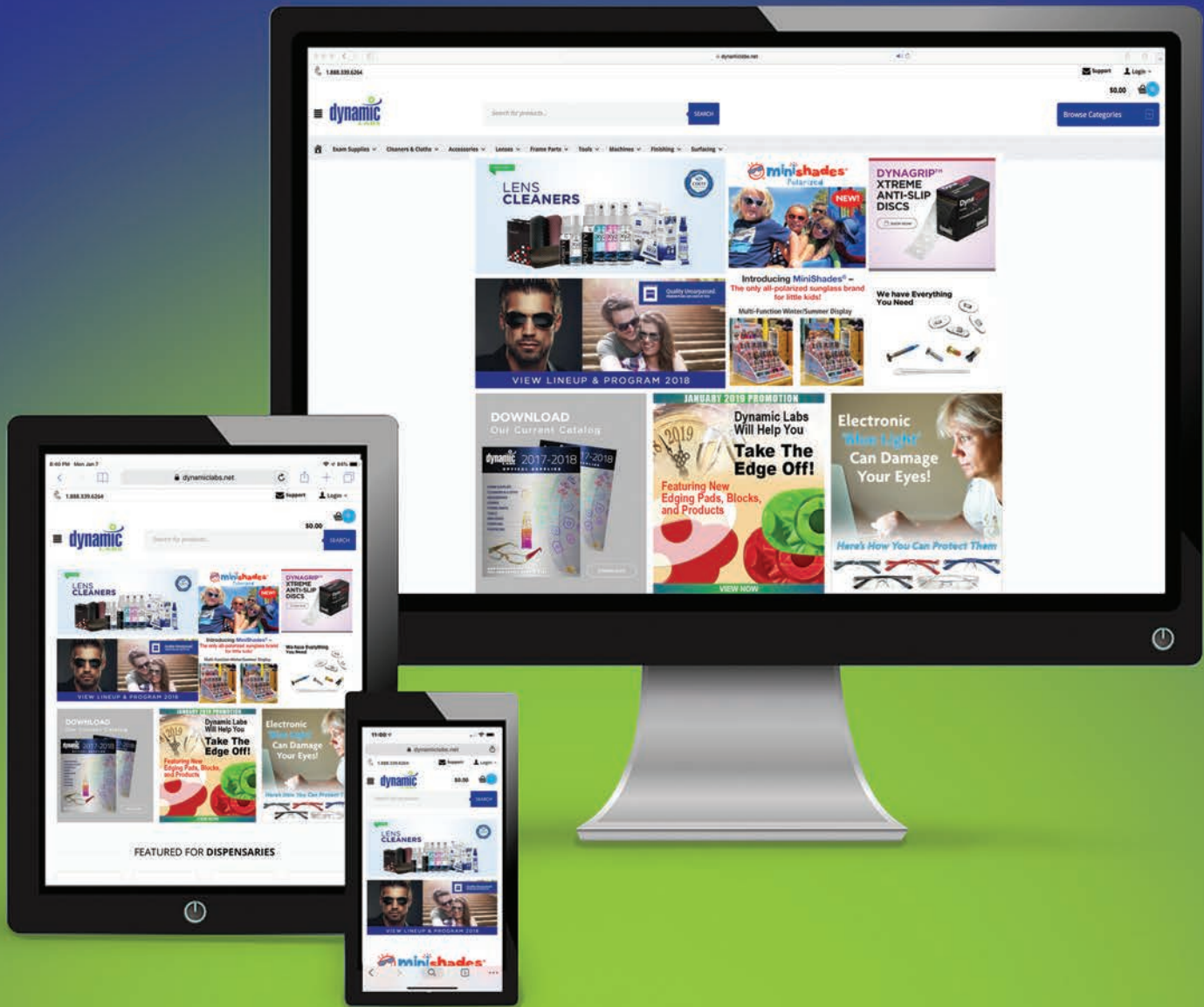

Our Website Features:

Preferred Customer Registration

Register Online for Our Preferred Customer Status and SAVE 2% on Every Order!

Monthly Featured Products & Promotions

We feature and promote our product line for labs and dispensaries with discounted pricing each month

Our Resource Center

Features free tradeshow registration for upcoming shows and more



Go to GooglePlay or the iPhone App store to download our App.

table of contents



exam supplies

pages 7-16

Wipes, Measuring Tools, Mydriatic Specs, Eye Patches, Eye Charts, Exam Equipment, Pharmaceuticals



tools

pages 85-117

Screwdrivers, Screwdriver Sets, Tweezers, Wrenches, Extractors, Measuring Tools, Pliers, Tool Kits, Tool Holders, Files, Drills & Taps, Soldering Supplies & Equipment, Misc. Tools, Lamps, Magnifiers



cleaners & cloths

pages 17-32

Lens Cleaners, Lens Cleaner Kits, Microfiber Pouches, Microfiber Cloths, Full Color Microfiber Cloths, Fog Stopper



machines

pages 119-130

Pupilometer, UV Light Meter, Marking Inks, Polishers, Groover, Lensometer, Edger, Ultrasonic Cleaners, Frame Warmers, Tint Systems, Salt, Bulbs



accessories

pages 33-58

Contact Lens Cases, Dispensing Trays, Magnetic Eyeglass Holders, Lens Protectors, Sunwear, Clip-Ons, Readers, Cords and Chains, Cases, Bags



finishing

pages 131-162

Blocking Pads, Anti-Slip Solutions, Blocks, AR Markers, Edging Pens, Felt Pads, Blades, Pattern Blanks, Edging Wheels, Job Trays, Gloves, Tint Unit Supplies, Tinting Systems, Dyes, Chemistry, Polishing Buffs, Compounds, Marking Inks, Marking Ink Remover



sun lenses

pages 59-65

Zeiss Store Packages, Zeiss Brand Lenses, Eclipse Sun Lenses, Zeiss Brand Wipes, Lens Cleaner



surfacing

pages 163-178

Surfacing Pads, Surfacing Tapes, Surfacing Supplies, Laps, Alloy, Ball Cutters, Generator Wheels, Chemistry, Polishers, Hardcoat, Spin Coater Parts, Lens Coatings



frame parts

pages 67-83

Nosepads, Screws, Component Organizers, Frame Tags, Tweezers, Liners & Cords, Adhesives, Screw & Component Kits, Bushing & Rimless Tools, Temple Tips

index by product

pages 179-181

index by item number

pages 183-192





End Unexpected “Slips”

Dynamic Labs Has an Industry Leading Lineup
of Top Performing Pads and Discs
Designed Specifically to Prevent Slipping and Twisting

NEW ProGrip2™

First combo pad with a built in anti-slip disc.

BigRed™

A tri-part pad featuring an anti-twist film between two layers.

NEW LensPro Precision™

Our newest blocking pad featuring a proprietary foam material that dramatically reduces slippage and twisting. Can be used on all lenses.

DynaGrip Xtreme™

Utilizing award winning technology of DynaGRIP™ and GRIPIT™.

LensPro Traction Control™

A super-hydrophobic spray that's fast drying and easy to remove.

Protect Your Expensive AR Coated and Hydrophobic Lenses Today!

exam supplies



Sanitizing Wipes & Cloths



Super Sani-Cloth Individual Wipes

- Extra large cloth size
- 50/box

5980027 **\$41.29**

Super Sani-Cloth Individual Wipes

- Large cloth size
- 50/box

5980026 **\$16.95**



Sani-Cloth Plus XL Wipes

- 7.5" x 15" cloth size
- 65/box

5980028 **\$18.95**

Sani-Cloth Plus Wipes

- 6" x 6.75" cloth size
- 160/box

5980029 **\$14.95**



Cotton Tipped Applicators



- 6" Non-Sterile
- 100 per pouch

7220110 **\$9.99/pouch**



Sani-Cloth HB XL Wipes

- 7.5" x 15" cloth size
- 65/box

5980030 **\$16.95**

Alcohol Pads & Dispensers



Push-Down Dispenser

8 oz.

5950004 **\$10.79**



Opaque Alcohol Dispenser

8 oz.

5950003 **\$17.99**



Sterile Alcohol Prep Pads

- Medium 1.8" x 3.5"
- 100/box (20 boxes per case.)

5950001 **\$3.45**

Sterile Alcohol Prep Pads

- Large 1.2" x 2.6"
- 200/box (10 boxes per case.)

5950002 **\$3.95**



Measuring Tools

Prescription Aligner

Verify seg heights and center of vision placements for accuracy and positioning

6621205 \$39.95

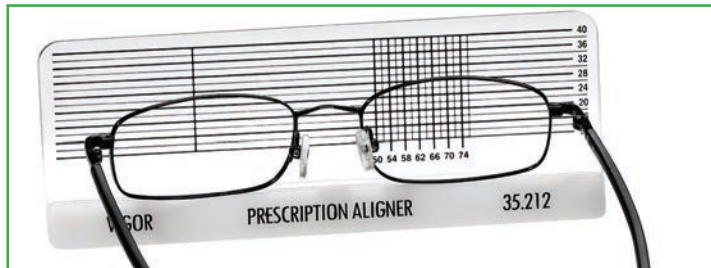

Seg Height Gauge

- Simply slips in frame
- Easy and accurate segment placement suggestion

6622005 \$11.95/pair

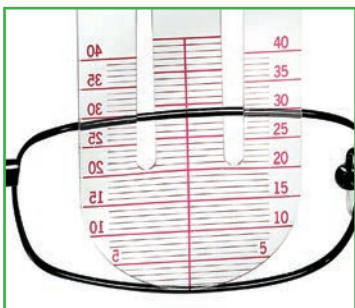

Rulers

6" Stainless Steel PD Ruler

6615001 \$3.00/ea 12+ \$2.50/ea



6" Clear PD Ruler

6615003 \$1.65/ea 6615013 12/pk \$13.65/ea



6" Black PD Ruler

6615103 \$2.25/ea



6" White PD Ruler

6615203 \$2.25/ea



Deluxe Digital Self-Calibrating Pupilometer



Automatically Recalibrates!

- Measures vertex distance
- Image brightness adjusting ability
- Adjustable shut off time
- LED light – longer battery life (AA batteries.)

6648770 \$399.95

2 or More \$369.95

6648774 Replacement Bulb \$29.95

Distometer

Easily measure vertex distance

6642106 \$139.95

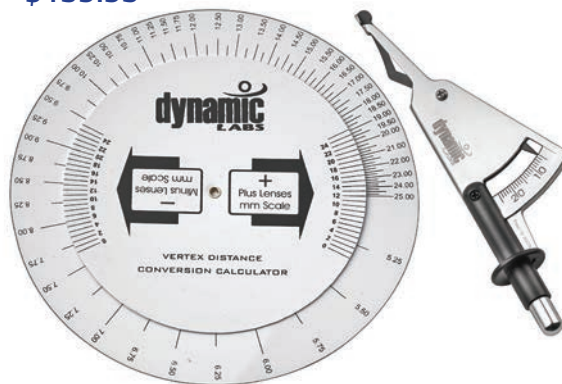

Mydriatic Specs

Children

Post-Mydriatic Specs w/Temples

3908025 \$25.95/pkg of 50 pair
 \$21.95/pkg (10 min.)



Slip-In Post-Mydriatic Specs

3921250 \$109.95/pkg of 250 pair
 \$95.95/pkg (5 min.)



Adult

Post-Mydriatic Specs w/Temples

3908125 \$25.95/pkg of 50 pair
 \$21.95/pkg (10 min.)



Slip-In Post-Mydriatic Specs

3922250 \$109.95/pkg of 250 pair
 \$95.95/pkg (5 min.)







Rollens Post Mydriatic Roll-Up Shield

100 per pack

3909101 \$49.95/pk
 5 or more \$44.95/pk
 36 or more \$39.95/pk

FREE
 Dispensor Box
 with 5 pks or more
 3909102

Showroom Mirror



- Magnifying mirror on flip side
- Quality swivel mirror
- Chrome finish



Pen Light



- Disposable
- Clean and efficient

6214600 \$4.95/ea
 12 or more \$3.95/ea

Occluder



- 9.5" long and 2.25" diameter

5910001 \$9.99/ea
 12 or more \$8.99/ea
 36 or more \$7.99/ea

5880395 \$46.95/ea
 4 or more \$39.95/ea



Trial Lens Set



226 Full Diameter (38mm)
Trial Lenses Sheres: + and - (Pairs):

- 0.12D
- 0.25-4.00 in .25 diopter increments
- 4.50-8.00 in .50 diopter increments
- 9.00- 16.00 in full diopter increments
- 18.00D and 20.00D

3910008 \$551.95



Trial Frame



- Metal cell trial frame
- Allows multitudes of adjustments with pinpoint accuracy
- Accommodates 3 pairs of trial lenses in front and 1 in the rear
- Separate right and left PD adjust 48-80mm

3910009 \$139.45



Eye Charts

Rosenbaum Pocket Vision Tester

3910002 \$24.95/ea

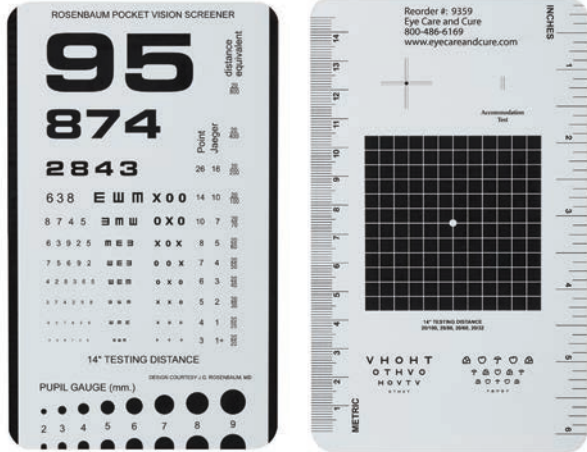

Pediatric Symbols

For 10 feet

3910007 \$19.99/ea

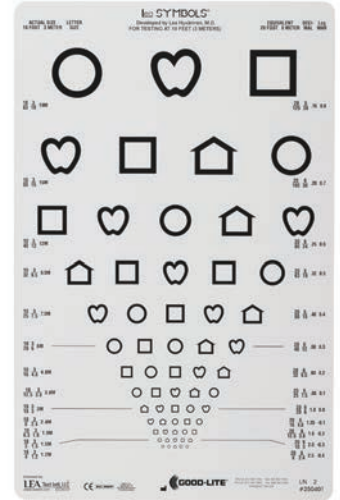

Tumbling 'E'

For 10 feet

3910005 \$19.99/ea

Snellen Eye

For 20 feet

3910000 \$19.99/ea



Standard Reading Test

For 16 inches

3910003 \$14.95/ea



Snellen Sloan

For 10 feet

3910006 \$19.99/ea

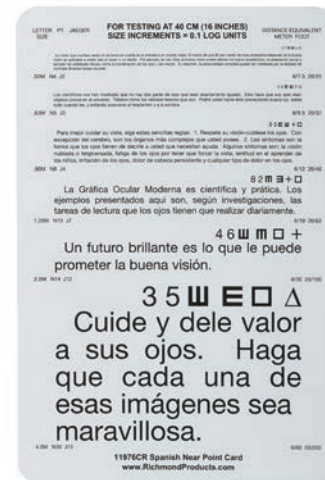

Spanish Reading Test

For 16 inches

3910004 \$14.95/ea



Eye Exam Equipment



DAS Digital Acuity System

Digital Clarity.
Digital Accuracy
Digital Efficiency.



The DAS system is designed around the latest in Android technology. Low power consumption, monitor flexibility, fast, sharp, concise graphics and an endless amount of media power are contained in a computer the size of a large thumb drive. Dual monitor system allows you to also see the chart on an Android pad.

The DAS system has all the most popular acuity tests at a price that is almost half the most popular brand sold today.

- Calibrate 8' to 25' mirrored or straight
- 19" monitor included (Optional 24")
- 720P, 1020P & 4K Options
- Snellen, Childrens, E's, Numbers, Contrast
- Color Tests, Aux Tests, Red/Green
- Upgradeable software
- Patient Content Platform allows for patient engagement opportunities while they wait; Educational Content, Entertaining Content, Photos, Internal Advertisement

| | | |
|------------|--------------------|------------|
| 3910066 | 20" Monitor | \$1,295.95 |
| 3910066-24 | 24" Monitor | \$1,595.95 |
| 3910061 | Wall Mount Bracket | \$62.95 |

Simple to Program.
Easy to Use!

Ishihara's Tests for Colour Deficiency

Shinobu Ishihara's universally known series of plates for discovering color blindness and red-green blindness. Twenty-four plate set, including four special plates used for determining the type and severity of color vision defect. Color plates come encased in a rugged, specially designed album that allows you to easily remove individual plates for ease of use.

3910001 \$249.00

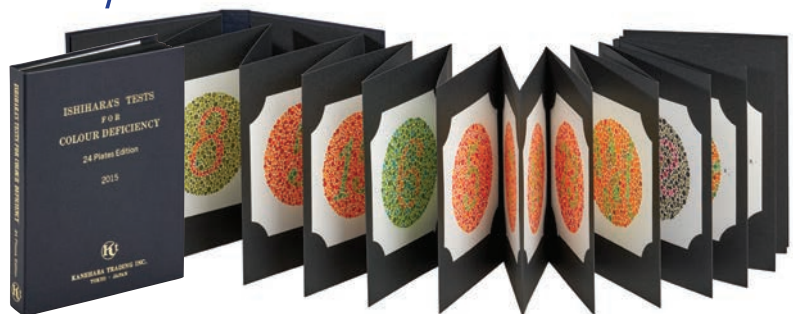

Pharmaceutical Supplies

To order items from the following two pages, we will need a copy of your current/valid professional license with your first order. Pharmaceutical supplies are not available in Canada or Puerto Rico.

Florida customers must submit a declaration of intent.

- MFG prices and brands are subject to change.
- Call for current prices.

All purchases are final and non-returnable.



| SKU# | DESCRIPTION |
|---------|---|
| 5980001 | Tropicamide Ophthalmic Solution 1%, 15mL |
| 5980002 | Tropicamide Ophthalmic Solution 0.5%, 15mL |
| 5980003 | Fluorescein/Benox Ophthalmic Solution w/dropper, .25% 5mL |
| 5980004 | Proparacaine HCL Ophthalmic Solution 0.5%, 15mL |
| 5980005 | Fluorescein/Proparacaine Ophthalmic Solution, 5mL |
| 5980006 | Fluorescein Sodium Single Dose Vial, 2mL, 12/Box |
| 5980007 | Paremyd Ophthalmic Solution, 1%/0.25%, 15mL |
| 5980008 | Kit IC (Indocyanine)-Green Angiography 25 mg Ampule, 6/PK |
| 5980009 | TetraVisc Ophthalmic Drops 0.5%, 5mL |
| 5980010 | Erythromycin Ophthalmic Ointment, 0.5%, 3.5gm Tube |
| 5980011 | Tetracaine Ophthalmic Solution 0.5%, 15mL |
| 5980012 | Cyclopentol HCL Ophthalmic Solution, 1%, 15mL |
| 5980013 | Phenylephrine HCL Ophthalmic Solution, 2.5%, 15mL |
| 5980014 | Phenylephrine HCL Ophthalmic Solution, 2.5%, 2mL |
| 5980015 | Phenylephrine Injectable, Single Dose Vial, N-R 1%, 1mL |
| 5980016 | Phenylephrine HCL Ophthalmic Solution, 10%, 5mL |

Pharmaceutical products will ship separately from any other products you may order. Pharmaceutical orders under \$200 are flat rate shipped at \$14.95. Pharmaceutical orders over \$200 are flat rate shipped at \$5.25.



Pharmaceutical Supplies

| SKU# | DESCRIPTION |
|---------|---|
| 5980017 | Lissamine Green Dye Strip, 100/Box |
| 5980018 | Neomycin-Poly-B Dex Ophthalmic Ointment, 1/8 oz. |
| 5980019 | Neomycin-Poly Dex Ophthalmic Solution, 0.1%, 5mL |
| 5980020 | Atropine Sulfate Ophthalmic Solution, 1%, 2mL |
| 5980021 | Atropine Sulfate Ophthalmic Ointment, 1%, 3.5gm |
| 5980022 | Kenalog-40 Injectable, 40mg/mL, 1 mL Vial |
| 5980023 | Homatropine Hydrobromide, 5%, 5mL Bottle, 36/Case |
| 5980024 | Ofloxacin Ophthalmic Solution, 0.3%, 10mL |
| 5980025 | Ofloxacin Ophthalmic Solution, 0.3%, 5mL |
| 5980031 | Lidocaine Topical Solution, 4%, 50mL |
| 5980032 | Fluorescein SOD Strips 300/BOX |
| 5980033 | Fluorescein SOD Strips 100/BOX |
| 5980034 | Phenylephrine 2.5% 15mL |
| 5980035 | Dexamethasone Solution, 10% 5mL |
| 5980037 | Tobramycin Solution, .030%, 5mL |

Foreign Body Removal Kit



- Rust ring remover
- Dix needle and spud
- Golf club spud
- Eye magnet with nylon loop
- Cilia forceps
- Castroviejo lacrimal dilator
- 23G curved lacrimal cannula
- Plastic sterilization tray

3910011 \$299.95/ea



Gloves

Latex Gloves

- Non-powdered and low protein
- 100/box



Small 5910089 Medium 5910090
 Large 5910091 X-Large 5910088
\$11.95/box 10 or more **\$9.95/box**

Non-Latex Gloves

- Non-powdered
- 100/box



Small 5910094 Medium 5910092
 Large 5910093
\$11.95/box 10 or more **\$9.95/box**

Nitrile Gloves

- Non-powdered
- 100/box



Small 5910095 Medium 5910096
 Large 5910097 X-Large 5910098
\$14.95/box 10 or more **\$12.95/box**

Wipes



Kimwipes EX-L

- 1 ply
- 4.4" x 8.4"
- 280/box (60 boxes per case)

2945100 **\$3.95/box**
 2945160 **\$199.95/case**

Large Kimwipes

- 3 ply
- 12" x 12"
- 119/box (15 boxes per case)

2954100 **\$12.95/box**
 2954115 **\$190.00/case**

Eye Patches



Adult Assorted Pastel Eye Patches

3910063 **\$28.91/pkg of 5 (assorted)**



Adult Standard Black Eye Patches

3910064 **\$28.91/pkg of 5**



Child Assorted Pastel Eye Patches

3910065 **\$28.91/pkg of 5 (assorted)**



cleaners & cloths



Lens Cleaners

Personalized Purity™



1 oz. Bottles

162 bottles/case
Imprinted Clear

| SKU# | 1-3 cases | 4-7 cases | 8 or more cases |
|---------|---------------|---------------|-----------------|
| 2017210 | \$0.93/bottle | \$0.75/bottle | \$0.66/bottle |

2 oz. Bottles

128 bottles/case
Imprinted Clear
Imprinted Blue
Imprinted Pink

| SKU# | 1-3 cases | 4-7 cases | 8 or more cases |
|----------|---------------|---------------|-----------------|
| 2027210 | \$1.10/bottle | \$0.86/bottle | \$0.75/bottle |
| 2027210B | \$1.10/bottle | \$0.86/bottle | \$0.75/bottle |
| 2027210P | \$1.10/bottle | \$0.86/bottle | \$0.75/bottle |

4 oz. Bottles

98 bottles/case
Imprinted Clear

| SKU# | 1-3 cases | 4-7 cases | 8 or more cases |
|---------|---------------|---------------|-----------------|
| 2047210 | \$1.35/bottle | \$1.11/bottle | \$0.91/bottle |

8 oz. Bottles

49 bottles/case
Imprinted Clear

| SKU# | 1-3 cases | 4-7 cases | 8 or more cases |
|---------|---------------|---------------|-----------------|
| 2087210 | \$2.00/bottle | \$1.80/bottle | \$1.60/bottle |



Lens Cleaner Display

Displays for 1, 2 and 4 oz. bottles hold 36 units.
Displays for 8 oz. bottles hold 18 units.

| | | |
|--------------------------|---------|-------------|
| 1 & 2 oz. bottle display | 2000000 | \$39.95 ea. |
| 4 oz. bottle display | 2000003 | \$39.95 ea. |
| 8 oz. bottle display | 2000005 | \$39.95 ea. |



Lens Cleaners

Purity™



1 oz. Bottles

162 bottles/case
Purity™ Brand Clear

| SKU# | 1-3 cases | 4-7 cases | 8 or more cases |
|---------|---------------|---------------|-----------------|
| 2017200 | \$0.93/bottle | \$0.75/bottle | \$0.66/bottle |

2 oz. Bottles

128 bottles/case
Purity™ Brand Clear

| SKU# | 1-3 cases | 4-7 cases | 8 or more cases |
|---------|---------------|---------------|-----------------|
| 2027200 | \$1.10/bottle | \$0.86/bottle | \$0.75/bottle |

4 oz. Bottles

98 bottles/case
Purity™ Brand Clear

| SKU# | 1-3 cases | 4-7 cases | 8 or more cases |
|---------|---------------|---------------|-----------------|
| 2047200 | \$1.35/bottle | \$1.11/bottle | \$0.91/bottle |

8 oz. Bottles

49 bottles/case
Purity™ Brand Clear

| SKU# | 1-3 cases | 4-7 cases | 8 or more cases |
|---------|---------------|---------------|-----------------|
| 2087200 | \$2.00/bottle | \$1.80/bottle | \$1.60/bottle |

1 Gallon Refill

Purity™ Brand Clear

| SKU# | 1 | 4 or more | 8 or more |
|---------|-------------|-------------|-------------|
| 2099200 | \$39.95/ea. | \$34.95/ea. | \$29.95/ea. |



Lens Cleaner Kits

Pages 20-24

- Available for 1 or 2 oz. cleaners
- Kits include a 6" x 7" microfiber cloth
- Kit features a hang tab for ease display



Lens Cleaners

Personalized UltraVue® Gel



1 oz. Bottles

| 162 bottles/case | SKU# | 1-3 cases | 4-7 cases | 8 or more cases |
|------------------|----------|---------------|---------------|-----------------|
| Imprinted Clear | 2611810 | \$1.03/bottle | \$0.85/bottle | \$0.76/bottle |
| Imprinted Pink | 2611810P | \$1.03/bottle | \$0.85/bottle | \$0.76/bottle |
| Imprinted Blue | 2611810B | \$1.03/bottle | \$0.85/bottle | \$0.76/bottle |

2 oz. Bottles

| 128 bottles/case | SKU# | 1-3 cases | 4-7 cases | 8 or more cases |
|------------------|----------|---------------|---------------|-----------------|
| Imprinted Clear | 2621810 | \$1.20/bottle | \$0.96/bottle | \$0.85/bottle |
| Imprinted Pink | 2621810P | \$1.20/bottle | \$0.96/bottle | \$0.85/bottle |
| Imprinted Blue | 2621810B | \$1.20/bottle | \$0.96/bottle | \$0.85/bottle |

4 oz. Bottles

| 98 bottles/case | SKU# | 1-3 cases | 4-7 cases | 8 or more cases |
|-----------------|---------|---------------|---------------|-----------------|
| Imprinted Clear | 2641810 | \$1.45/bottle | \$1.21/bottle | \$1.01/bottle |

8 oz. Bottles

| 49 bottles/case | SKU# | 1-3 cases | 4-7 cases | 8 or more cases |
|-----------------|---------|---------------|---------------|-----------------|
| Imprinted Clear | 2681810 | \$2.10/bottle | \$1.90/bottle | \$1.70/bottle |

US Patent 8,993,501



NEW PRODUCT

Lens Cleaners

UltraVue® Gel

Unique Patented Formulation

- An industry first that changes the industry standard
- Gel is a more efficient lens cleaner than any liquid
- Superior cleaning as each drop stays longer on the lens



1 oz. Bottles

| 162 bottles/case | SKU# | 1-3 cases | 4-7 cases | 8 or more cases |
|-----------------------|----------|---------------|---------------|-----------------|
| UltraVue® Brand Clear | 2611800 | \$1.03/bottle | \$0.85/bottle | \$0.76/bottle |
| UltraVue® Brand Pink | 2611800P | \$1.03/bottle | \$0.85/bottle | \$0.76/bottle |
| UltraVue® Brand Blue | 2611800B | \$1.03/bottle | \$0.85/bottle | \$0.76/bottle |

2 oz. Bottles

| 128 bottles/case | SKU# | 1-3 cases | 4-7 cases | 8 or more cases |
|-----------------------|----------|---------------|---------------|-----------------|
| UltraVue® Brand Clear | 2621800 | \$1.20/bottle | \$0.96/bottle | \$0.85/bottle |
| UltraVue® Brand Pink | 2621800P | \$1.20/bottle | \$0.96/bottle | \$0.85/bottle |
| UltraVue® Brand Blue | 2621800B | \$1.20/bottle | \$0.96/bottle | \$0.85/bottle |

Lens Cleaner Kits

Pages 22-26

- Available for 1 or 2 oz. cleaners
- Kits include a 6" x 7" microfiber cloth
- Kit features a hang tab for easy display



US Patent 8,993,501

Lens Cleaning Kits

Personalized 1 and 2 oz. Purity™



1 oz. Bottles

| 50 kits/case | SKU# | 100 Kits | 500 Kits | 1,000 Kits |
|-----------------|----------|---------------|---------------|---------------|
| Imprinted Clear | 2000091 | \$2.13/bottle | \$2.03/bottle | \$1.93/bottle |
| Imprinted Pink | 2000091P | \$2.13/bottle | \$2.03/bottle | \$1.93/bottle |
| Imprinted Blue | 2000091B | \$2.13/bottle | \$2.03/bottle | \$1.93/bottle |

2 oz. Bottles

| 50 kits/case | SKU# | 100 Kits | 500 Kits | 1,000 Kits |
|-----------------|----------|---------------|---------------|---------------|
| Imprinted Clear | 2000092 | \$2.27/bottle | \$2.17/bottle | \$2.07/bottle |
| Imprinted Pink | 2000092P | \$2.27/bottle | \$2.17/bottle | \$2.07/bottle |
| Imprinted Blue | 2000092B | \$2.27/bottle | \$2.17/bottle | \$2.07/bottle |

Additional Optionals

3-In-One Keychain Screwdriver **\$0.53/per kit**

Cloth Imprinting

Black or White Ink **Add \$0.10/per kit (500 Min.)**

Silver or Gold Ink **Add \$0.20/per kit (500 Min.)**



Kits Contains:

- One Cleaner Spray (1 or 2 oz.)
- One 6"x7" Microfiber Cleaning Cloth (Mixed Colors)



Lens Cleaning kits

Purity™ Brand 1 and 2 oz.



1 oz. Bottles

| 50 kits/case | SKU# | 100 Kits | 500 Kits | 1,000 Kits |
|---------------------|------------|---------------|---------------|---------------|
| Purity™ Brand Clear | 2000091BR | \$2.13/bottle | \$2.03/bottle | \$1.93/bottle |
| Purity™ Brand Pink | 2000091BRP | \$2.13/bottle | \$2.03/bottle | \$1.93/bottle |
| Purity™ Brand Blue | 2000091BRB | \$2.13/bottle | \$2.03/bottle | \$1.93/bottle |

2 oz. Bottles

| 50 kits/case | SKU# | 100 Kits | 500 Kits | 1,000 Kits |
|---------------------|------------|---------------|---------------|---------------|
| Purity™ Brand Clear | 2000092BR | \$2.27/bottle | \$2.17/bottle | \$2.07/bottle |
| Purity™ Brand Pink | 2000092BRP | \$2.27/bottle | \$2.17/bottle | \$2.07/bottle |
| Purity™ Brand Blue | 2000092BRB | \$2.27/bottle | \$2.17/bottle | \$2.07/bottle |

Additional Optionals

3-In-One Keychain Screwdriver **\$0.53/per kit**

Cloth Imprinting

Black or White Ink **Add \$0.10/per kit (500 Min.)**

Silver or Gold Ink **Add \$0.20/per kit (500 Min.)**



Kits Contains:

- One Cleaner Spray (1 or 2 oz.)
- One 6"x7" Microfiber Cleaning Cloth (Mixed Colors)

Lens Cleaning Kits

Personalized 1 and 2 oz. UltraVue® Gel



1 oz. Bottles

| 50 kits/case | SKU# | 100 Kits | 500 Kits | 1,000 Kits |
|-----------------|------------|---------------|---------------|---------------|
| Imprinted Clear | 2000091UV | \$2.23/bottle | \$2.13/bottle | \$2.03/bottle |
| Imprinted Pink | 2000091UVP | \$2.23/bottle | \$2.13/bottle | \$2.03/bottle |
| Imprinted Blue | 2000091UVB | \$2.23/bottle | \$2.13/bottle | \$2.03/bottle |

2 oz. Bottles

| 50 kits/case | SKU# | 100 Kits | 500 Kits | 1,000 Kits |
|-----------------|------------|---------------|---------------|---------------|
| Imprinted Clear | 2000092UV | \$2.37/bottle | \$2.27/bottle | \$2.17/bottle |
| Imprinted Pink | 2000092UVP | \$2.37/bottle | \$2.27/bottle | \$2.17/bottle |
| Imprinted Blue | 2000092UVB | \$2.37/bottle | \$2.27/bottle | \$2.17/bottle |

US Patent 8,993,501

Additional Optionals

3-In-One Keychain Screwdriver **\$0.53/per kit**

Cloth Imprinting

Black or White Ink **Add \$0.10/per kit (500 Min.)**

Silver or Gold Ink **Add \$0.20/per kit (500 Min.)**



Kits Contains:

- One Cleaner Spray (1 or 2 oz.)
- One 6"x7" Microfiber Cleaning Cloth (Mixed Colors)



**NEW
PRODUCT**

Lens Cleaning kits

UltraVue® Gel Brand 1 and 2 oz.

EXAM SUPPLIES

CLEANERS & CLOTHS

ACCESSORIES

SUN LENSES

FRAME PARTS

TOOLS

MACHINES

FINISHING

SURFACING

INDEX



1 oz. Bottles

| 50 kits/case | SKU# | 100 Kits | 500 Kits | 1,000 Kits |
|-----------------------|--------------|---------------|---------------|---------------|
| UltraVue® Brand Clear | 2000091UVBR | \$2.23/bottle | \$2.13/bottle | \$2.03/bottle |
| UltraVue® Brand Pink | 2000091UVBRP | \$2.23/bottle | \$2.13/bottle | \$2.03/bottle |
| UltraVue® Brand Blue | 2000091UVBRB | \$2.23/bottle | \$2.13/bottle | \$2.03/bottle |

2 oz. Bottles

| 50 kits/case | SKU# | 100 Kits | 500 Kits | 1,000 Kits |
|-----------------------|--------------|---------------|---------------|---------------|
| UltraVue® Brand Clear | 2000092UVBR | \$2.37/bottle | \$2.27/bottle | \$2.17/bottle |
| UltraVue® Brand Pink | 2000092UVBRP | \$2.37/bottle | \$2.27/bottle | \$2.17/bottle |
| UltraVue® Brand Blue | 2000092UVBRB | \$2.37/bottle | \$2.27/bottle | \$2.17/bottle |

US Patent 8,993,501

Additional Optionals

3-In-One Keychain Screwdriver **\$0.53/per kit**

Cloth Imprinting

Black or White Ink **Add \$0.10/per kit (500 Min.)**

Silver or Gold Ink **Add \$0.20/per kit (500 Min.)**



Kits Contains:

- One Cleaner Spray (1 or 2 oz.)
- One 6"x7" Microfiber Cleaning Cloth (Mixed Colors)



Microfiber Pouch Kits

Personalized Purity™ Pouch Kits

1 oz. Imprinted Purity™ Kit

100 kits \$2.05/per kit
 500 kits \$1.95/per kit
 1,000 kits \$1.85/per kit



2A000091 Clear
 2A000091P Pink
 2A000091B Blue

2 oz. Imprinted Purity™ Kit

100 kits \$2.20/per kit
 500 kits \$2.10/per kit
 1,000 kits \$2.00/per kit



2A000092 Clear
 2A000092P Pink
 2A000092B Blue

Personalized UltraVue® Gel Pouch Kits

1 oz. Imprinted UltraVue® Kit

100 kits \$2.20/per kit
 500 kits \$2.10/per kit
 1,000 kits \$2.00/per kit



2A000091UV Clear
 2A000091UVP Pink
 2A000091UVB Blue

US Patent 8,993,501

2 oz. Imprinted UltraVue® Kit

100 kits \$2.30/per kit
 500 kits \$2.20/per kit
 1,000 kits \$2.10/per kit



2A000092UV Clear
 2A000092UVP Pink
 2A000092UVB Blue

US Patent 8,993,501

Additional Optionals

Customize a pouch kit for a 1 oz. or 2 oz. Lens Cleaner in a Microfiber Pouch

IMPRINTING:
 Black or White Imprinting

Add \$0.10/per kit

NEW Silver or Gold Imprinting

Add \$0.20/per kit

■ 3-In-One Keychain Screwdriver **Add \$0.53/per kit**

■ Imprinted Pouch (Min. 500)

■ Imprinted Cloth (Min. 500)

■ Upgrade Pouch to Photo-Fun **Add \$0.50/per kit**



Microfiber Pouches



- Protect Your Glasses With This Handy 4" x 7" Drawstring Pouch
- Constructed of Sturdy Microfiber Cloth
- Can Be Used to Clean Your Glasses Too!

Purity™

- 10 Pouch Minimum **\$1.01/ea.**
- 100 Pouches **\$0.81/ea.**
- 500 Pouches **\$0.71/ea.**
- 1,000 Pouches **\$0.61/ea.**

Imprinted

500 Pouch Minimum

Pouch Imprinting

Standard Inks

Add **\$0.20/per cloth**

Metallic Ink (Gold or Silver)

Add **\$0.30/per cloth**



Black
2A92001
Imprinted 2A92011

Light Blue
2A92002
Imprinted 2A92012

Gray
2A92003
Imprinted 2A92013

Burgundy
2A92004
Imprinted 2A92014



Yellow
2A92005
Imprinted 2A92015

Dark Blue
2A92006
Imprinted 2A92016

Lavender
2A92008
Imprinted 2A92018

Pink
2A92009
Imprinted 2A92019

Purity™ Photo-Fun

Full Color Photo-Printed

- 10 Pouch Minimum **\$1.35/ea.**
- 100 Pouches **\$1.25/ea.**
- 500 Pouches **\$1.15/ea.**
- 1,000 Pouches **\$1.05/ea.**



Swimmer
2A92020

Ski Jump
2A92021

The Princess
2A92022

Ocean Sunset
2A92023

Beach Palm
2A92024

Beach Chairs
2A92025





Microfiber Cloths



Serrated Edges/Bulk

- 6" x 7" microfiber cloth
 - Sold 100 per box by color
- 1/Box by color **\$62.59/box**
 5 Boxes or more **\$58.59/box**
 10 Boxes or more **\$42.59/box**



Imprinted 5 Box Minimum

Cloth Imprinting

Standard Inks | Metallic Ink (Gold or Silver)

Add **\$0.10/per cloth** | Add **\$0.20/per cloth**

| Color | (No printing) | Imprinted |
|------------|---------------|-----------|
| Black | 2942001 | 2942301 |
| Light Blue | 2942002 | 2942302 |
| Gray | 2942003 | 2942303 |
| Burgundy | 2942004 | 2942304 |
| Yellow | 2942005 | 2942305 |
| Dark Blue | 2942006 | 2942306 |
| Green | 2942007 | 2942307 |
| Lavender | 2942008 | 2942308 |
| Pink | 2942009 | 2942309 |
| White | 2942010 | 2942310 |
| Red | 2942012 | 2942312 |
| Orange | 2942013 | 2942313 |
| Gold | 2942014 | 2942314 |

Serrated Edges/In Pouch

- Sold 100 per box by color (1 Cloth per pouch)
 - Folded into a clear plastic pouch
- 1/Box by color **\$0.79/pouch**
 5 Boxes or more **\$0.69/pouch**
 10 Boxes or more **\$0.49/pouch**
- Imprinted** 5 Box Minimum
- Cloth Imprinting**
 Basic Colors Add **\$0.25/per cloth**
 Metallic Ink (Gold or Silver)
 Add **\$0.35/per cloth**

| Color | (No printing) | Imprinted |
|------------|---------------|-----------|
| Black | 2942101 | 2942401 |
| Light Blue | 2942102 | 2942402 |
| Gray | 2942103 | 2942403 |
| Burgundy | 2942104 | 2942404 |
| Yellow | 2942105 | 2942405 |
| Dark Blue | 2942106 | 2942406 |
| Green | 2942107 | 2942407 |
| Lavender | 2942108 | 2942408 |
| Pink | 2942109 | 2942409 |
| White | 2942110 | 2942410 |
| Red | 2942112 | 2942412 |
| Orange | 2942113 | 2942413 |
| Gold | 2942114 | 2942414 |



Microfiber Cloths

Chamois/Bulk

- 6" x 7" microfiber cloth
- Sold 100 per box by color

1/Box by color **\$74.74/box**
 5 Boxes or more **\$64.74/box**
 10 Boxes or more **\$48.74/box**



Imprinted Cloth Imprinting

Standard Inks Metallic Ink (Gold or Silver)
 Add **\$0.10/per cloth** Add **\$0.20/per cloth**

| Color | (No printing) | Imprinted |
|------------|---------------|-----------|
| Black | 2952001 | 2952301 |
| Light Blue | 2952002 | 2952302 |
| Gray | 2952003 | 2952303 |
| Burgundy | 2952004 | 2952304 |
| Yellow | 2952005 | 2952305 |
| Dark Blue | 2952006 | 2952306 |
| Green | 2952007 | 2952307 |
| Lavender | 2952008 | 2952308 |
| Pink | 2952009 | 2952309 |
| White | 2952010 | 2952310 |
| Red | 2952012 | 2952312 |
| Orange | 2952013 | 2952313 |
| Gold | 2952014 | 2952314 |

Chamois/In Pouch

- Sold 100 per box by color (1 Cloth per pouch)
 - Folded into a clear plastic pouch
- 1/Box by color **\$0.85/pouch**
 5 Boxes or more **\$0.75/pouch**
 10 Boxes or more **\$0.55/pouch**

Imprinted 5 Box Minimum

Cloth Imprinting
 Basic Colors Add **\$0.25/per cloth**
 Metallic Ink (Gold or Silver)
 Add **\$0.35/per cloth**

| Color | (No printing) | Imprinted |
|------------|---------------|-----------|
| Black | 2952101 | 2952401 |
| Light Blue | 2952102 | 2952402 |
| Gray | 2952103 | 2952403 |
| Burgundy | 2952104 | 2952404 |
| Yellow | 2952105 | 2952405 |
| Dark Blue | 2952106 | 2952406 |
| Green | 2952107 | 2952407 |
| Lavender | 2952108 | 2952408 |
| Pink | 2952109 | 2952409 |
| White | 2952110 | 2952410 |
| Red | 2952112 | 2952412 |
| Orange | 2952113 | 2952413 |
| Gold | 2952114 | 2952414 |



Microfiber Full Color Cloths

Holiday Cloths



Sport Cloths

NEW PRODUCT

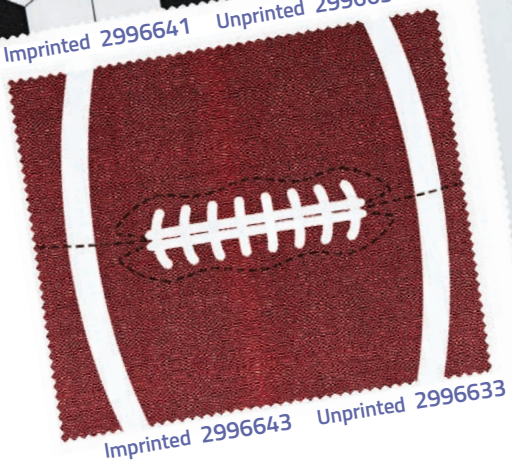

| Quantity | Imprinted Per Box | Unprinted Per Box |
|------------------|-------------------|-------------------|
| 1 box of 100 | ---- | \$96.48 |
| 2 boxes or more | \$122.48 | \$96.48 |
| 5 boxes or more | \$96.49 | \$86.48 |
| 10 boxes or more | \$86.49 | \$76.48 |



Microfiber Cloths

Sewn Edges/Bulk

- 6" x 7" Microfiber Cloth
- Sold 100 per box by color
- Features sewn edges

1/Box by color **\$73.28/box**
 5 Boxes or more **\$63.28/box**
 10 Boxes or more **\$53.28/box**



Imprinted 5 Box Minimum

Cloth Imprinting

Standard Inks | Metallic Ink (Gold or Silver)
 Add **\$0.10/per cloth** Add **\$0.20/per cloth**

| Color | (No printing) | Imprinted |
|------------|---------------|-----------|
| Black | 2943001 | 2943301 |
| Light Blue | 2943002 | 2943302 |
| Gray | 2943003 | 2943303 |
| Burgundy | 2943004 | 2943304 |
| Dark Blue | 2943006 | 2943306 |
| Gold | 2943007 | 2943307 |

Sewn Edges/In Pouch

- Sold 100 per box by color
- Folded into a sturdy black plastic pouch

1/Box by color (1 cloth per pouch) **\$0.90/pouch**
 5 Boxes or more **\$0.80/pouch**
 10 Boxes or more **\$0.60/pouch**

Imprinted 5 Box Minimum

Cloth Imprinting

Basic Colors | Metallic Ink (Gold or Silver)
 Add **\$0.25/per cloth** Add **\$0.35/per cloth**



| Color | (No printing) | Imprinted |
|------------|---------------|-----------|
| Black | 2943101 | 2943401 |
| Light Blue | 2943102 | 2943402 |
| Gray | 2943103 | 2943403 |
| Burgundy | 2943104 | 2943404 |
| Dark Blue | 2943106 | 2943406 |
| Gold | 2943107 | 2943407 |

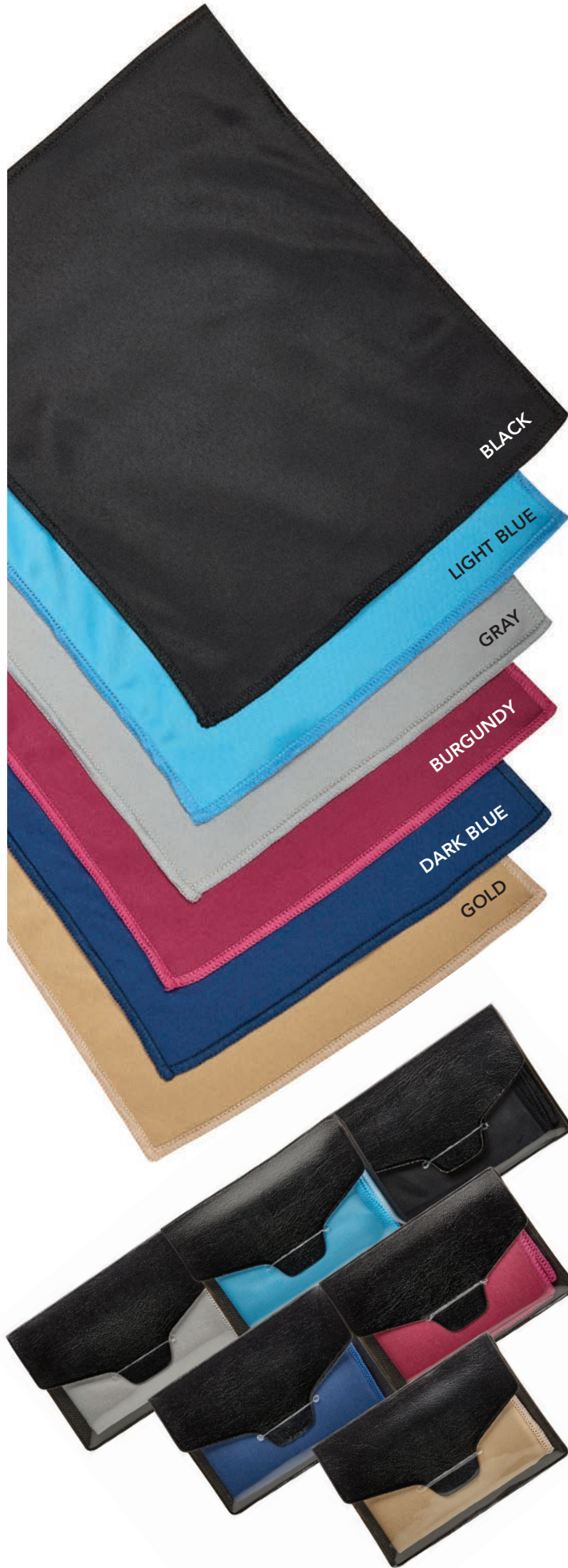

Lens Fog Stoppers



Eyeglasses



Swimming Goggles



Safety Eyewear



Ski Goggles

Premium AR Fog Stopper™

Designed Specifically for AR Coated Lenses

- Prevents fogging on all lenses
- Great for swim goggles, sport goggles, safety eyewear, and eyeglasses
- 10mL bottle
- Sold in display boxes of 24 bottles

2024301 \$9.95/bottle

1 Box (24 bottles)

2024324 \$190.95/box

10 Boxes \$166.95/box

20 Boxes \$142.95/box

**NEW
PRODUCT**



Purity Fog Stopper™

Lens Cleaner

- Stop Fogged Lenses & Mirrors Cold!
- Great for Swim Goggles, Sport Goggles and Non-AR Coated Lenses!
- 2 oz. bottle, 128 bottles/case

2024300

1-3 cases \$1.25/bottle

4-7 cases \$1.15/bottle

8 or more cases \$0.95/bottle



accessories



Contact Lens Cases



50 Assorted Colors

Colorful convenience for your customers!

3008599 \$13.95 ea.
20 or more \$9.95 (1000 pieces)



Flat Packs 2-Piece in Blister Pack

Sold 12 packages per color.

3008091 Orange 59¢/pkg
3008111 Green
48 packages 55¢/pkg
96 packages 49¢/pkg

Clip-On Mini Brow Light

Conveniently attaches to the bridge of your glasses.

3949001 \$9.95/ea.



Dispensing Trays

Present Your Frames With the Quality of Expensive Jewelry



7.75" wide x 14.25" long x 0.75" deep.

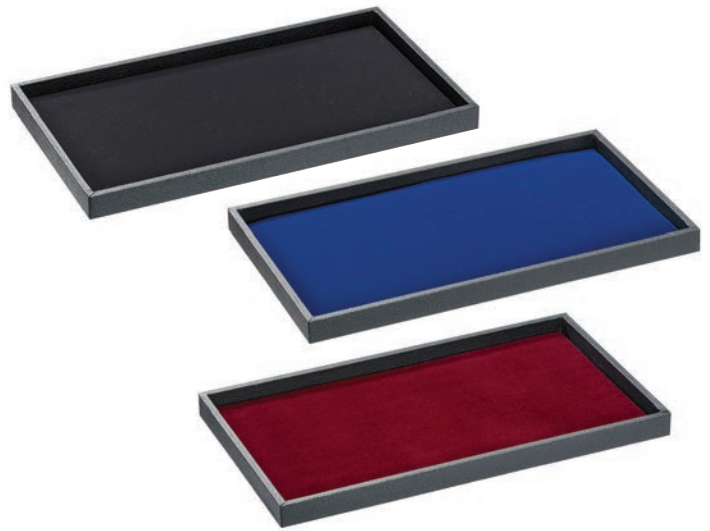

6214752 Black Velvet \$19.95/ea.
6214753 Blue Velvet
6214754 Red Velvet

Visor Clips

Attaches to the visor in your vehicle. Simple, safe, and convenient way to store your glasses. Sold as individual blister cards.

1-49 pieces \$1.60/ea.
50-59 pieces \$1.59/ea.
100-149 pieces \$1.49/ea.



12-Piece Assortment Display

3675000 \$20.95/ea.
6 or more \$18.95/ea.



3675001 Black 3675002 Fuchsia

3675003 Lime 3675004 Cherry

3675007 Silver 3675005 Blue 3675006 Champagne





Magcessory Pewter Collection

**NEW
PRODUCT**



Hearts
3302088 \$14.95/ea.



Feather
3302087 \$14.95/ea.



Ribbon Bow
3302086 \$14.95/ea.



Butterfly
3302085 \$14.95/ea.

Magnetic Eyeglass Holders

READEREST.®

Exclusively from Dynamic Labs!

Sold 8 per package.



Classic Black

3302083 \$63.95/pkg
4 or more \$50.95/pkg



Stainless Steel

3302081 \$63.95/pkg
4 or more \$50.95/pkg



Swarovski Crystal

3302082 \$71.95/pkg
4 or more \$55.95/pkg



READEREST.® Counter Display

3302032 \$179.95

Display with 24 pieces.



Sunglass Lens Protector

RIPCLEAR

Your Ripclear Package Includes:

- 2 Ripclear Lens Protectors
- 2 Packaged Wet Lens Wipes
- 1 High Quality Microfiber Cloth
- 4 Dust Removal Stickers For Easy Application
- 2 Dust Removal Sheet For Dust Removal
- Clear Application Instructions
- A Ripclear Sticker



COSTA DEL MAR

| | |
|-------------------------------|----------------|
| <u>Costa Del Mar Whitetip</u> | <u>3290001</u> |
| <u>Costa Del Mar Halfmoon</u> | <u>3290002</u> |
| <u>Costa Del Mar Blake</u> | <u>3290003</u> |
| <u>Costa Del Mar Cut</u> | <u>3290004</u> |
| <u>Costa Del Mar Loreto</u> | <u>3290005</u> |
| <u>Costa Del Mar Remora</u> | <u>3290006</u> |
| <u>Costa Del Mar Brine</u> | <u>3290007</u> |
| <u>Costa Del Mar Cat Cay</u> | <u>3290008</u> |

OAKLEY

| | |
|--------------------------------------|----------------|
| <u>Oakley Crossrange</u> | <u>3290010</u> |
| <u>Oakley Elmont M</u> | <u>3290011</u> |
| <u>Oakley Flak 2.0</u> | <u>3290012</u> |
| <u>Oakley Frogskins</u> | <u>3290013</u> |
| <u>Oakley Game Changer</u> | <u>3290014</u> |
| <u>Oakley Holbrook</u> | <u>3290015</u> |
| <u>Oakley Latch Square</u> | <u>3290016</u> |
| <u>Oakley MainLink</u> | <u>3290017</u> |
| <u>Oakley Double Edge</u> | <u>3290018</u> |
| <u>Oakley Drop Point</u> | <u>3290019</u> |
| <u>Oakley Flak Jacket</u> | <u>3290020</u> |
| <u>Oakley Frogskins LX</u> | <u>3290021</u> |
| <u>Oakley Fuel Cell</u> | <u>3290022</u> |
| <u>Oakley Half Jacket 2.0 XL</u> | <u>3290023</u> |
| <u>Oakley Half Jacket</u> | <u>3290024</u> |
| <u>Oakley Half Jacket XLJ</u> | <u>3290025</u> |
| <u>Oakley Hijinx</u> | <u>3290026</u> |
| <u>Oakley Juliet</u> | <u>3290027</u> |
| <u>Oakley Monster Dog</u> | <u>3290028</u> |
| <u>Oakley Sliver XL</u> | <u>3290029</u> |
| <u>Oakley Sliver</u> | <u>3290030</u> |
| <u>Oakley Split Jacket</u> | <u>3290031</u> |
| <u>Oakley Straight Jacket (2007)</u> | <u>3290032</u> |
| <u>Oakley Straight Link (58MM)</u> | <u>3290033</u> |
| <u>Oakley Straight Link (61MM)</u> | <u>3290034</u> |
| <u>Oakley Stringer</u> | <u>3290035</u> |
| <u>Oakley Turbine</u> | <u>3290036</u> |
| <u>Oakley Twoface</u> | <u>3290037</u> |
| <u>Oakley Moonlighter</u> | <u>3290038</u> |

RAY-BAN

| | |
|---|----------------|
| <u>Ray-Ban RB3026 Aviator</u> | |
| <u>Large Metal II (62mm)</u> | <u>3290039</u> |
| <u>Ray-Ban RB3025 Aviator</u> | |
| <u>Large (55mm)</u> | <u>3290040</u> |
| <u>Ray-Ban RB4180 Aviator</u> | |
| <u>Liteforce (58mm)</u> | <u>3290041</u> |
| <u>Ray-Ban RB3025 Aviator</u> | |
| <u>Large (58mm)</u> | <u>3290042</u> |
| <u>Ray-Ban RJ95065 Junior Kid's Aviator</u> | <u>3290043</u> |
| <u>Ray-Ban RB8301 Aviator (56mm)</u> | <u>3290044</u> |
| <u>Ray-Ban RB2132 New Wayfarer (52mm)</u> | <u>3290045</u> |
| <u>Ray-Ban RB4195 Wayfarer</u> | |
| <u>Liteforce (52mm)</u> | <u>3290046</u> |
| <u>Ray-Ban RB4207 New Wayfarer</u> | |
| <u>Liteforce (55mm)</u> | <u>3290047</u> |
| <u>Ray-Ban RB2140 Original Wayfarer</u> | |
| <u>Classic (50mm)</u> | <u>3290048</u> |
| <u>Ray-Ban RB2140 Original</u> | |
| <u>Wayfarer Classic (54mm)</u> | <u>3290049</u> |
| <u>Ray-Ban RB3016 Clubmaster (49mm)</u> | <u>3290050</u> |

SMITH LOWDOWN

| | |
|----------------------|----------------|
| <u>Smith Lowdown</u> | <u>3290051</u> |
|----------------------|----------------|

SPY OPTIC

| | |
|---------------------------|----------------|
| <u>Spy Optic Dirk</u> | <u>3290052</u> |
| <u>Spy Optic Bounty</u> | <u>3290053</u> |
| <u>Spy Optic Discord</u> | <u>3290054</u> |
| <u>Spy Optic General</u> | <u>3290055</u> |
| <u>Spy Optic Rover</u> | <u>3290056</u> |
| <u>Spy Optic Cooper</u> | <u>3290057</u> |
| <u>Spy Optic Dirty Mo</u> | <u>3290058</u> |
| <u>Spy Optic Logan</u> | <u>3290059</u> |
| <u>Spy Optic Tackle</u> | <u>3290060</u> |
| <u>Spy Optic Flyer</u> | <u>3290061</u> |



Sunglass Lens Protector

RIPCLEAR

**NEW
PRODUCT**

Now, Protecting Your Sunglass Lenses Is As Easy As Protecting Your Device Screens

The only product of its kind. Ripclear Sunglass Protectors are designed to protect your sunglasses from the harshest conditions you can face. Whether out on a ride, relaxing at the beach, or just using sunglasses in your day to day activities Ripclear will keep you protected. Ripclear protectors adhere directly to the lens and are transparent to the user. Ripclear protects from scratches, scrapes, bumps, tears, and any other hazards that your sunglasses lens will face. Stop scratches today and get Ripclear protected.

Ripclear is Easily Installed and Removed to Maintain Pristine Optical Quality for Its Users

Ripclear Lens Protectors are a patented thin film technology that protects eyewear lenses, device screens, and other sensitive surfaces all while meeting ANSI Z87 military rated optical clarity.

FREE Countertop Displays
1 each: 20pcs P.O.P and wooden block
with the purchase of 20 pieces or more
\$12.50/2pk

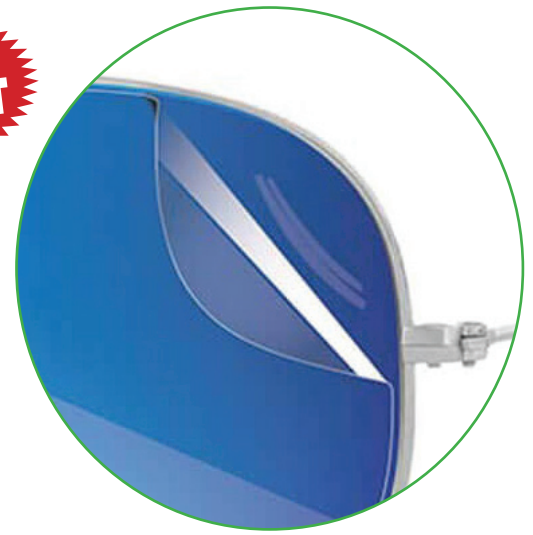

Ray-Ban Aviator



Oakley Cross Range



Costa-Cat-Cay



3291000
Display for w/20 pcs



3292000
Wooden Block Display

Fit Over Sunwear

HAVEN

- 100% UVA/UVB protection
- Shatter proof - 2x more scratch resistant
- Polarized to eliminate glare
- Oil, water & smudge resistant
- Fashion designer adornments
- Contemporary styling
- Wraparound lenses for maximum view
- Vented frames to reduce fogging

Dahlia Signature

Crystal/Crystal
3455099 \$21.95



Fits over Rx glasses not exceeding
5"W x 1-1/2"H (127mm x 39mm)

Freesia Signature

Gray
3455201 \$21.95



Fits over Rx glasses not exceeding
5-1/4"W x 1-3/8"H (134mm x 37mm)



18pc Standing

Fits Over Sunglasses: 18 pieces
Dimensions: 20" H x 7" W x 8" D

3455103 \$149.95

Sunglass Countertop

Fits Over Sunglasses: 6 pieces
Dimensions: 20" H x 7" W x 8" D

3455101 \$49.95



Dahlia Leopard

Mid Black/Gray
3455100 \$21.95



Fits over Rx glasses not exceeding
5"W x 1-1/2"H (127mm x 39mm)

Windmere

Matt Black/Gray
3455400 \$19.95



Fits over Rx glasses not exceeding
5-1/4"W x 1-1/2"H (134mm x 39mm)

Freesia Croc

Amber
3455200 \$21.95



Fits over Rx glasses not exceeding
5-1/4"W x 1-3/8"H (134mm x 37mm)

Sunset

Mocha/Amber
3455300 \$19.95



Fits over Rx glasses not exceeding
5-1/4"W x 1-1/2"H (134mm x 39mm)

Foxen

Mid Blue/Gray
3455500 \$19.95



Fits over Rx glasses not exceeding
5"W x 1-1/2"H (127mm x 39mm)

Denali

Amber
3455600 \$19.95



Fits over Rx glasses not exceeding
5"W x 1-1/2"H (127mm x 39mm)



Polarized Children's Sunglasses



Dynamic Labs Is Proud to Offer Our Clients MiniShades® Polarized Sunglasses

Polarized grey lenses offer 100% UV protection in colorful, on-trend, good-looking frames that are impact resistant and sized just for the kiddies! Made from a specially formulated rubber material, these sunglasses come in two sizes: 0-3 years old, and 3-7+ years old. Super comfy and virtually indestructible, MiniShades are "Safe, Strong & Super Cute®".



LIFETIME WARRANTY FOR ONE TIME REPLACEMENT IF LOST OR DAMAGED!



Ages 0-3

Baby Blue
38130103



Black Satin
38130603



Little Lilac
38130703



Powder Pink
38130203



Ages 3-7

Grape Jelly
38130937



Red Hot
38130837



Electric Blue
38130337



Hot Pink
38130437



Jet Black
38130537



Individual Pairs \$10.50/ea.

Multi-Function Winter/Summer Display

Pre-Loaded w/22 pair and Two Seasonal Headers

- | | |
|---------------------|-----------------------|
| Display Contents: | 2 Pairs Electric Blue |
| 2 Pairs Baby Blue | 2 Pairs Hot Pink |
| 2 Pair Black Satin | 5 Pair Jet Black |
| 2 Pair Little Lilac | 2 Pair Red Hot |
| 3 Pair Powder Pink | 2 Pair Grape Jelly |



Polarized and Mirrored Clip-On Sunglasses



High Quality Clip-Ons in Cases With Polarized Lenses for Maximum Glare Reduction and a Unique, Enclosed Spring Bridge

- With over 2,500 possible combinations, we'll have what you are looking for!
- Ask your sales rep for additional details
- Delivery is 1-2 weeks



Visionaries Clip-On

Mirrored & Polarized, 3D, or Rimless Sunglasses with Case **\$24.95**
 Rimmed Sunglasses with Case **\$22.95**

Visionaries Fit Kit

Contains a Selection of 36 Frames

Use your visionaries shade control fit kit as the powerful selling tool. Demonstrate our polarized sun clips to every customer who does not purchase Rx sun wear and watch your profits sizzle!

36000036 \$499.95

How to Order Clip-Ons

- Choose your shape from the 20 rimmed frame styles or 8 rimless frame styles displayed on page 35. Determine horizontal (A) and vertical (B) measure.
- Then select frame color from the 4 frame samples shown at the top of page 36.
- Finally, choose lens color from the dozen examples to the right of the same page.

RIM STYLE "36"
for traditional rimmed clip-ons

RIM STYLE "37"
for new rimless clip-ons

Example:

| | | | | | |
|----------------|------------|----------------|---------------|-------------|------------|
| 36 | 05 | 48 | 22 | 3 | 40 |
| RIM STYLE CODE | STYLE CODE | HORIZ. MEASURE | VERT. MEASURE | FRAME COLOR | LENS COLOR |

"36" for Traditional; "05" indicates Slim Rectangle; "4822" is a 48mm x 22mm lens measurement; "3" tells us you want a gunmetal frame; and "40" is the Classic Silver mirrored lenses.

The product number is **36054822340**

If you have any questions, please call your sales rep. They will be happy to assist you!

NOTE: All sales final - NO RETURNS



Fully Rimmed Clip-Ons

Rimless Clip-Ons

SQR – Square 36 01



Available in 53x45, 55x46, 57x48, 58x49*

EXX – Extended Rectangle 36 09

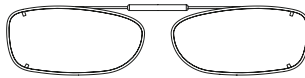

Available in 55x26.5, 57x27.5**

REX – Rectangle 37 02

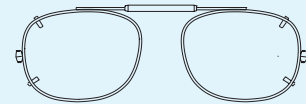

Rimless available in 50x37, 52x39, 54x40, 56x43

REX – Rectangle 36 02



Available in 48x35, 50x37, 52x39, 54x40, 56x43

RND – Round 36 10

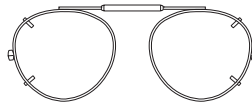

Available in 47x42, 49x43, 50x45

TRX – Tru Rectangle 37 03



Rimless available in 48x27, 50x28, 52x29, 54x30, 56x34

TRX – Tru Rectangle 36 03



Available in 48x27, 50x28, 52x29, 54x30, 56x34, 53x35**

OVL – Oval 36 11

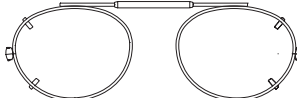

Available in 42x33, 44x34, 46x36, 48x37, 50x39, 52x41

XLO – Lo Rectangle 37 04

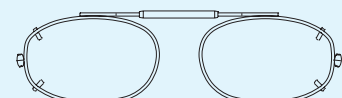

Rimless available in 50x32, 52x33, 54x35, 56x35

XLO – Lo Rectangle 36 04

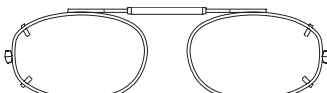

Available in 44x27, 46x29, 48x30, 50x32, 52x33, 54x35, 56x35

OLO – Lo Oval 36 12

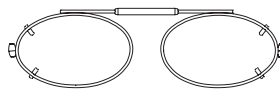

Available in 41x26, 44x27, 45x30, 47x30, 50x31

SLM – Slim Rectangle 37 05

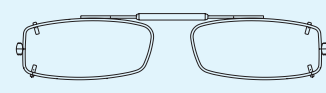

Rimless available in 54x25

SLM – Slim Rectangle 36 05



Available in 48x22, 50x23, 52x24, 54x25, 56x28**

MDO – Mod Oval 36 13

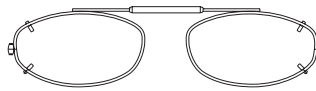

Available in 50x28, 52x29**

MRX – Mod Rectangle 37 06

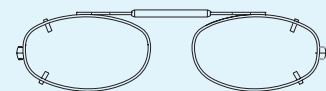

Rimless available in 52x31

MRX – Mod Rectangle 36 06

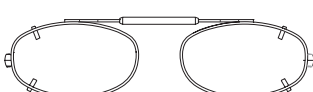

Available in 46x27, 47x28, 50x29, 52x31, 54x33

ALM – Almond 36 14

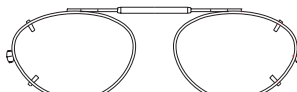

Available in 47x34, 49x35, 51x36

MDX – MDX Rectangle 37 07



Rimless available in 52x29, 54x31

MDX – MDX Rectangle 36 07

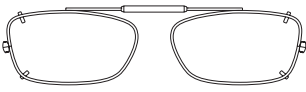

Available in 52x29, 54x31**

CAT – Cat Eye 36 15

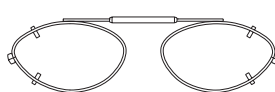

Available in 47x29, 49x30, 51x31

OVL – Oval 37 11

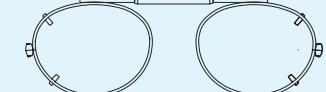

Rimless available in 50x39

WAY 36 17

NEW



Available in 52x41, 54x43, 57x45

HIP 36 18

NEW



Available in 53x38, 56x39, 58x42

ROC 36 19

NEW



Available in 53x41, 55x43

WAL 36 20

NEW



Available in 52x35, 54x37, 56x39

* Not Available in Black
 **Not Available in Gold
 Rimless clips only available with gunmetal hardware and gray lenses, only in the sizes and shapes indicated above.

NOTE: All sales final- NO RETURNS

Polarized and Mirrored Clip-On Sunglasses



Frame Colors



- Gold 1
- Bronze 2
- Gunmetal 3
- Black 4

Lens Colors

Polarized

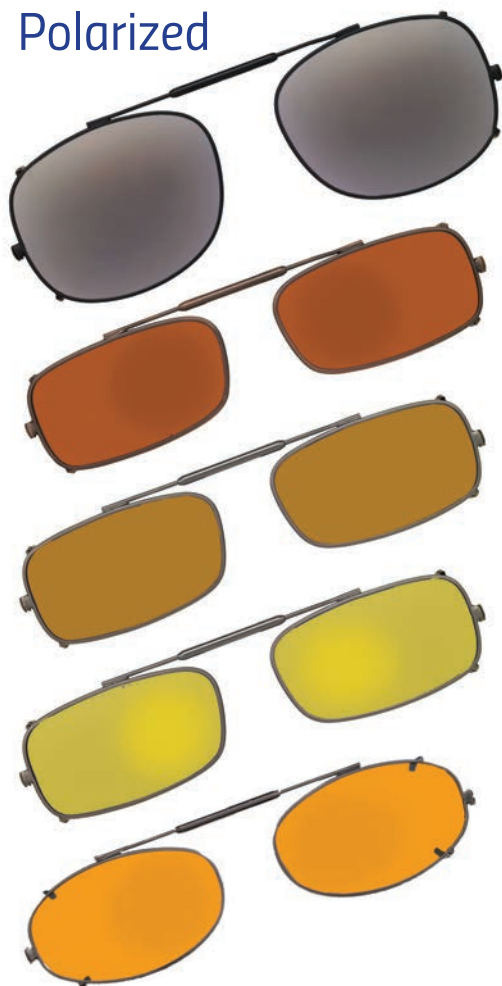

- Grey 74
- Copper 64
- Brown 61
- Yellow 62
- Blu-Blocker 80

Mirrored & Polarized



- Black Flash 60
- Classic Silver 40
- Deep Blue 66
- Caribbean Green 63
- Crimson Red 67
- Copper Driving 50
- HCP Yellow 41

3-D Lenses



3-D 34





Reader Collections

PRIVATE | EYES.®

High Quality, High Performance, and Fashionable Frames!

Build Your Custom Reader Business With 6 Each Of 6 Frames Of Your Choice In Any Power Along With Our Premium Display

- High quality Polycarbonate Lens
- Durable anti-scratch lens with AR coating,
- Fashionable frames, with 6 diopters, at a similar price point to retail
- Functional carrying case
- Never sold in drugstores
- Private Eyes are exclusive to Eye Care Professionals
- Fully adjustable frames, wire core temples, and spring hinges

Available in the following diopters:

- +1.00
- +1.25
- +1.50
- +1.75
- +2.00
- +2.50

Ordering your reader(s):

Add the power to the end of the style code. (Found under style description.)

EXAMPLE: Ordering a Audrey +2.0

345227200

\$15.95/ea.



Each reader comes with a fashionable case.



Our sleek counter top fixture holds six fashionable styles, each in six diopters.

Order 36 Pair and Get a Free Display

3452161 \$549.95/display w/36 readers



Reader Collections

PRIVATE | EYES.®

MENS

Conrad



Brown/Matte Black
345238xxx

- Full rim, plastic frame with faux wood finish and retro keyhole bridge
- Integrated spring hinge

Lens Width: 48 Bridge Width: 20 Temple Length: 142

Chandler



Tortoise
345237xxx

- Full rim, patterned plastic frame with retro, keyhole bridge
- Integrated spring hinge

Lens Width: 48 Bridge Width: 19 Temple Length: 140

Hobbes



Tortoise
345236xxx

- Full rim, combination frame with patterned plastic front and tips with metal temples
- Integrated spring hinge

Lens Width: 52 Bridge Width: 16 Temple Length: 140

Hugh



Gunmetal
345219xxx

- Semi-rimless brushed metal frame and black plastic temples with metal rivets
- Integrated spring hinge

Lens Width: 43 Bridge Width: 20 Temple Length: 140

Beckett



Satin Gunmetal/Matte Black
345228xxx

- Full rim with plastic temple that features embossed pattern
- Integrated spring hinge

Lens Width: 54 Bridge Width: 32 Temple Length: 145

Fletch



Gunmetal
345230xxx

- Full rim brushed metal frame and black plastic temples with metal rivets
- Integrated spring hinge

Lens Width: 50 Bridge Width: 34 Temple Length: 140

Chris



Gunmetal
345229xxx

- Rimless rectangle with etched black plastic temples and gunmetal trim
- Integrated spring hinge

Lens Width: 53 Bridge Width: 31 Temple Length: 140

Larz



Shiny Black/Dark Gunmetal
345218xxx

- Full rim plastic frame and tips with metal patterned temples
- Integrated spring hinge

Lens Width: 51 Bridge Width: 28 Temple Length: 140



LADIES

Polly



Purple
345231xxx

- Full rim flat metal frame with embossed textured temples and plastic temple tips
- Integrated spring hinge

Lens Width: 54 Bridge Width: 33 Temple Length: 135

Kylene



Tortoise/Purple
345235xxx

- Full rim, plastic frame with leaf-patterned front and solid pop color temples
- Integrated spring hinge

Lens Width: 54 Bridge Width: 15 Temple Length: 143

Thixie



Matt Brown/Brown on Crystal
345217xxx

- Full rim flat metal frame with engraved plastic temples
- Integrated spring hinge

Lens Width: 51 Bridge Width: 17 Temple Length: 140

Nicola



Toroise/Teal
345234xxx

- Full rim, plastic frame with patterned front and solid pop color temples
- Integrated spring hinge

Lens Width: 48 Bridge Width: 19 Temple Length: 138

Paulette



Tortoise/Wine
345232xxx

- Full rim plastic frame and temples in wine tortoise color with metal rivets detail on frame
- Integrated spring hinge

Lens Width: 52 Bridge Width: 34 Temple Length: 140

Elana



Purple
345233xxx

- Full rim, frame with striated pattern in modern rectangle shape
- Integrated spring hinge

Lens Width: 53 Bridge Width: 18 Temple Length: 145

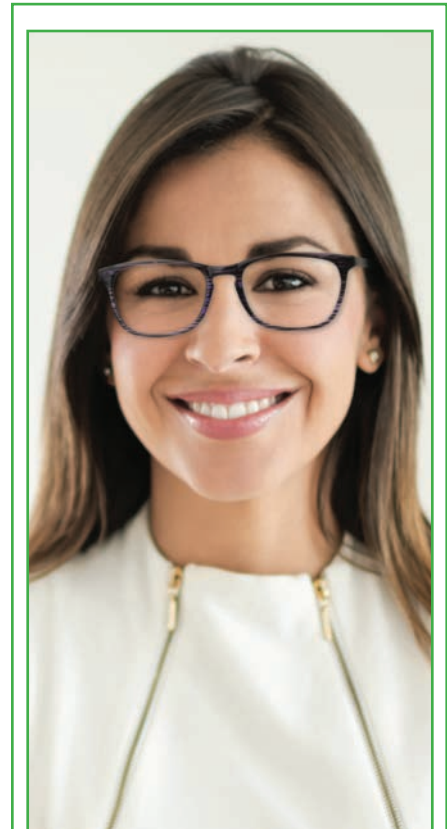

Available in the following diopters:

+1.00 +1.25 +1.50

+1.75 +2.00 +2.50

Ordering your reader(s):

Add the power to the end of the style code. (Found under the style/material description.)

EXAMPLE: Ordering a Polly +2.0

345231200 **\$15.95/ea.**

Reader Collections

See Clear

Foldable Readers

- Compact frame with telescoping arms fold up to fit into it's own sleek container with a magnetic closure
- Features spring hinges for extra comfort and durability
- Available as Gun Metal, Silver, and Black

Powers Available:

+1.0, +1.5, +1.75, +2.0, +2.25, +2.5, +3.0

Note: +2.25 and +2.75 only available in Gun Metal and Black

Lens Width: 45 Bridge Width: 21 Temple Length: 130

**NEW
PRODUCT**



Ordering your reader(s):

Add the power to the end of the color product code below.

EXAMPLE: Ordering a Gun Metal +2.0 **3422109200**

Gun Metal **3422109**

Silver **3422106**

Black **3422101**

\$14.95/ea.





Reader Collections

Blue Light™ Readers

BlueLight™ Readers are designed to protect people from the harmful bluelight rays that come from computers, cell phones and tablets. You can enjoy your device from the comfort of your bed at night and get a restful deeper sleep without the effects of harmful electronic blue light!

- Great for computer, cell phone users, and pc game players
- Help protect your eyes from high-energy blue rays (400-500nm range).
- Frames are available in 5 colors; Red, Teal, Black, Navy & Clear

Powers Available:
+1.0, +1.5, +2.0, +2.5



Each reader comes with a clear plastic fashionable case.



Red 34510



Teal 34500



Black 34530



Navy 34520



Clear 34540

Ordering your reader(s):
Add the power to the end of the style code.
(Found under the reader shown.)

EXAMPLE: Ordering Blue +2.0

34520200 **\$12.95/ea.**

20 pc. assortment
34500000 \$249.95

Cords & Chains

Art & Elegance In An Eyeglass Holder

Elegant ways for your customers to keep track of their eyeglasses!

Necklace Hangers



Light Blue
3301815



Pink
3301819



Brown/White
3301841

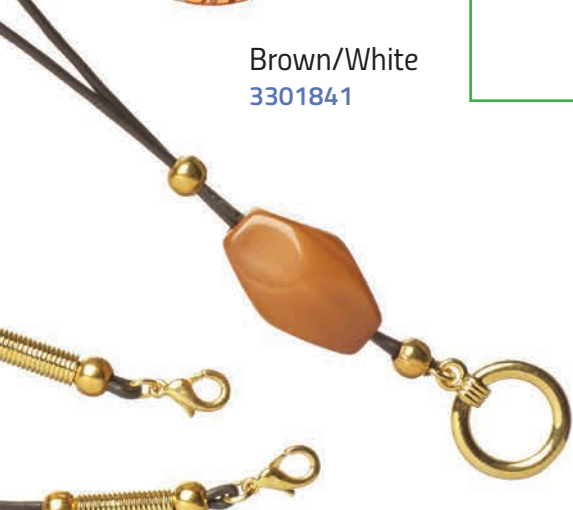

Tiger Eye
3301899



Gold Snake
3201901

Gold Knife-Edge Link
3202001

Silver Herringbone
3202102

Eyeglass Chains

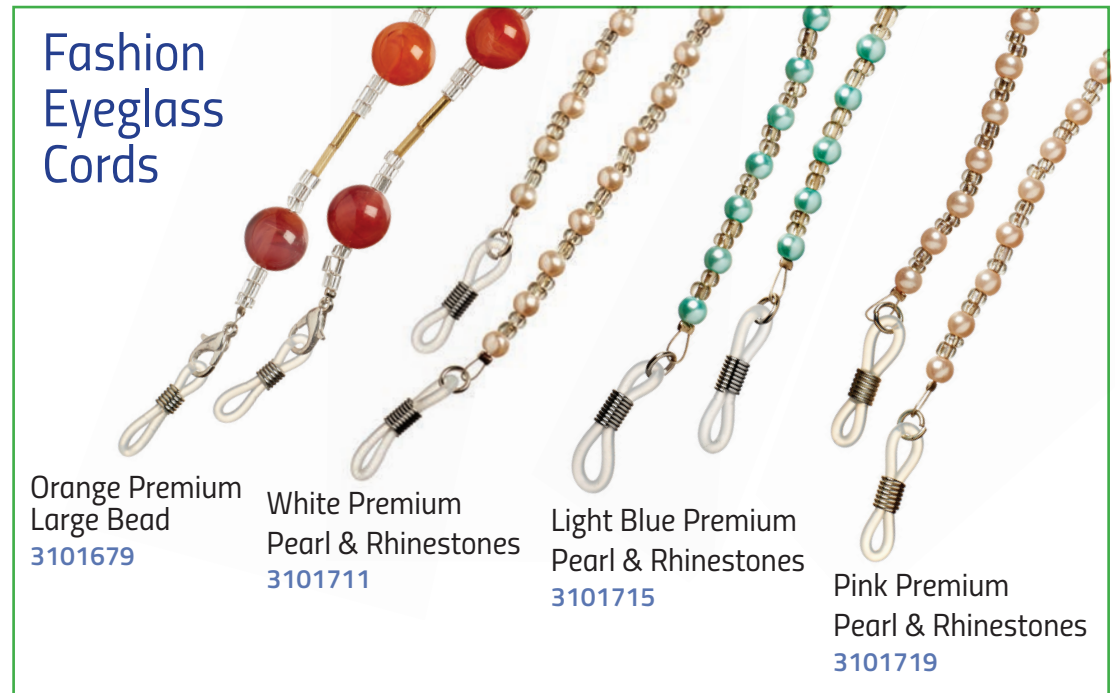

Fashion Eyeglass Cords

Orange Premium Large Bead
3101679

White Premium Pearl & Rhinestones
3101711

Light Blue Premium Pearl & Rhinestones
3101715

Pink Premium Pearl & Rhinestones
3101719

Necklace Hangers

12 or more \$5.15/ea.
\$4.15/ ea.

Quick-Pick Pack

18 Assorted
3301800 \$68.99

Eyeglass Chains

12 or more \$5.15/ea.
\$4.15/ ea.

Quick-Pick Pack

18 Assorted
3202000 \$68.99

Fashion Eyeglass Cords

12 or more \$5.15/ea.
\$4.15/ ea.

Quick-Pick Pack

25 Assorted
3101000 \$68.99



Nylon Cords



Contempo Cords

12 Per Color \$1.06/ea.
 72 Cords 96¢/ea
 144 Cords 76¢/ea.

Quick-Pick Pack

12 of Each Color
 3107000 \$63.41

Floaties Buoyant Cords

Prevents loss of your glasses during swimming.

\$3.15/ea. 24 or more \$2.65/ea.
 48 or more \$2.45/ea.

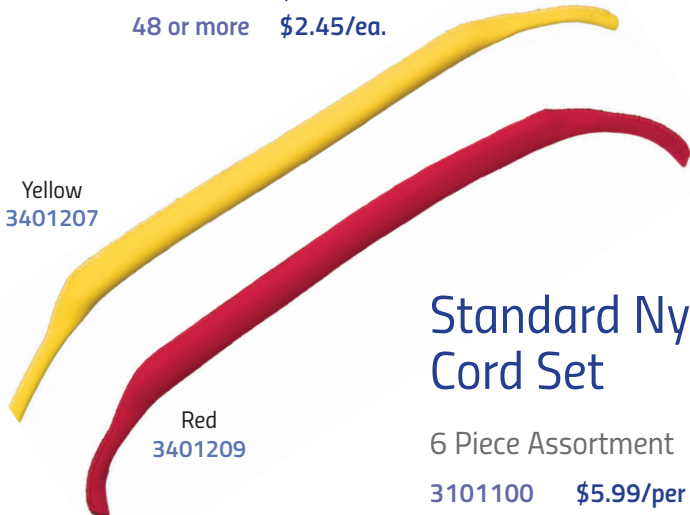

Yellow
 3401207

Red
 3401209

Standard Nylon Cord Set

6 Piece Assortment

3101100 \$5.99/per assortment
 12 or more \$4.99/per assortment



Sports and Children's Cords

Sports Cords

12 Per Color \$1.06/ea.



Solid Black
3101203

Solid Brown
3101204

Solid Dark Blue
3101225

Black/Blue
Houndstooth
3101335

Black/Red
Houndstooth
3101339

72 Cords 96¢/ea. 144 Cords 86¢/ea.
288 Cords 76¢/ea. 500 Cords 66¢/ea.

Quick-Pick Pack 12 of Each Color 3106000 \$54.39

Wide Nylon Sports Cords

12 Per Color \$1.07/ea.

72 Cords 97¢/ea. 144 Cords 87¢/ea.
288 Cords 77¢/ea. 500 Cords 67¢/ea.

Quick-Pick Pack

24 of Each Color
3105000 \$61.93



Black
3101403

Red
3101409

Dark Blue
3101435

Quick-Pick Sports Packs

48 each of Asst'd Wide Nylon and Sports Cords

3102000 \$89.95

48 each of Asst Wide Nylon, Sports Cords, Plus 24 Floaties

3103000 \$136.95

Children's Sponge Bob Nylon Cords

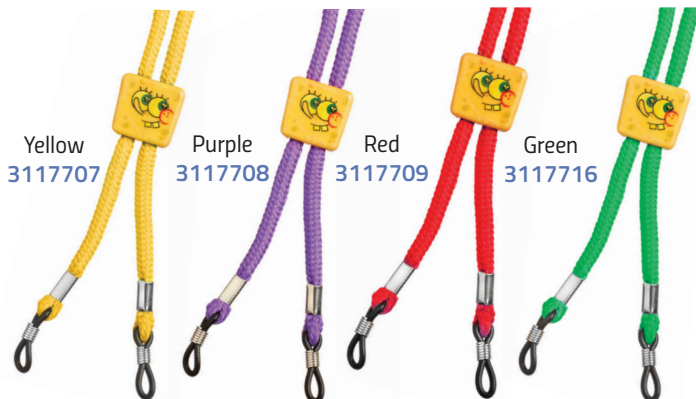

Yellow
3117707

Purple
3117708

Red
3117709

Green
3117716

6 Per Color \$1.99/ea. 48 or more \$1.59/ea.
144 or more \$1.29/ea. 288 or more \$0.99/ea.

Quick-Pick Pack

12 of Each Color 3104000 \$69.95

Children's Nylon Cord Set



6 Piece Assortment

3117000 \$5.99/per assortment

12 or more \$4.99/per set

24 or more \$4.59/per set



Cases



Case Imprinting

- One time plate fee of \$75.00
- 500 pc/minimum
- Delivery in approximately four weeks

9999998 15¢/per case

Men's Clamshell Cases

Small



Brown 3010021
Black 3010031
Burgundy 3010101

\$1.20 ea
300 asst., \$1.09 ea
600 asst., \$0.99 ea

Medium



Brown 3011021
Black 3011031
Burgundy 3011101

\$1.20 ea
300 asst., \$1.09 ea
600 asst., \$0.99 ea

Large



Brown 3012021
Black 3012031
Burgundy 3012101

\$1.35 ea
300 asst., \$1.30 ea
600 asst., \$1.20 ea

Small Diamond



Brown 3010023
Black 3010033
Burgundy 3010103

\$1.35 ea
300 asst., \$1.30 ea
600 asst., \$1.20 ea

Medium Diamond



Brown 3011023
Black 3011033
Burgundy 3011103

\$1.35 ea
300 asst., \$1.30 ea
600 asst., \$1.20 ea

Large Diamond



Brown 3012023
Black 3012033
Burgundy 3012103

\$1.45 ea
300 asst., \$1.40 ea
600 asst., \$1.30 ea

Cases

Men's Clamshell, Sunglass, & Fliptop Cases

Medium Metallic



Blue 3011073
 Black 3011003
 Silver 3011035
 Green 3011019

\$1.20 ea
 400 asst., \$1.05 ea

Two-Tone



Blue/Black 3012386
 Pink/Black 3012086
 White/Black 3012396
 Red/Black 3012116

\$1.35 ea
 400 asst., \$1.20 ea

Hard Plastic 2-Tone



Blue 3075071
 Pink 3075081
 Orange 3075091

\$1.20 ea
 300 asst., \$1.09 ea
 600 asst., \$1.05 ea

Sunglass Cases

Extra Large Clamshell



Brown 3013021
 Black 3013031

\$1.85 ea
 300 asst., \$1.75 ea

Extra Large Fiber Zipper Clamshell



Red Zipper 3013231
 Black Zipper 3013131

\$2.15 ea
 300 asst., \$1.95 ea

Aluminum Fliptop



Brown 3014031
 Black 3014021

\$2.95 ea
 300 asst., \$2.85 ea
 600 asst., \$2.75 ea

Semi-Hard Fold Over



Black 3004032

\$1.45 ea
 400 asst., \$1.35 ea



Cases

Men's Slip In Cases

With Clip



Brown 3003021
Black 3003031

\$0.95ea
200 asst., \$0.85 ea
400 asst., \$0.75 ea

Clip With Pocket Flap



Brown 3023021
Black 3023031

\$1.09 ea
200 asst., \$0.99 ea
400 asst., \$0.89 ea

Slip In



Brown 3002021
Black 3002031

\$0.75 ea
200 asst., \$0.65 ea
400 asst., \$0.59 ea

Ladie's Fold Over Cases

Fabric



Black 3004333
Taupe 3004343
Silver 3004353
Strawberry 3004363

\$1.65 ea
400 asst., \$1.45 ea

Pattern



Small Blue 3004071
Med. Blue 3004072
Small Red 3004111
Med. Red 3004112

\$1.55 ea
200 asst., \$1.45 ea
400 asst., \$1.35 ea

Semi-Hard Pattern



Black 3004209

\$1.65 ea
200 asst., \$1.45 ea
400 asst., \$1.35 ea

Cases

Ladies Slip In & Foldable Cases

Lady's Fabric Slip In



Purple 3002189
 Black 3002039
 Blue 3002079
 Pink 3002089

\$0.89 ea
 400 asst., \$0.79 ea

Lady's Vinyl Slip In



Tan 3002023
 Pink 3002083
 Green 3002190
 Burgundy 3002101

\$0.89 ea
 400 asst., \$0.79 ea

Lady's Glitter Slip In



Black 3002333
 Taupe 3002343
 Silver 3002353
 Strawberry 3002363

\$1.05 ea
 400 asst., \$0.95 ea

Foldable Glitter Finish



Black 3007031
 Blue 3007066
 Pink 3007069
 Pearl 3007080

\$2.95 ea
 300 asst., \$2.85 ea
 600 asst., \$2.75 ea

Foldable Matte Finish



Black 3016031
 Blue 3016066
 Red 3016067

\$2.95 ea
 300 asst., \$2.85 ea
 600 asst., \$2.75 ea

Elegant Aluminum



Brown 3015021
 Black 3015031
 Pink 3015069
 Sky Blue 3015070

\$2.49 ea
 200 or more \$2.30 ea
 400 or more \$2.15 ea



Cases

Children's Cases

Unicorn Handle Case



3006069 \$2.95 ea
 300 or more \$2.85 ea
 600 or more \$2.75 ea

Cupcake Handle Case



3006070 \$2.95 ea
 300 or more \$2.85 ea
 600 or more \$2.75 ea

Kid's Brites



Children's Plastic

Blue 3075078
 Pink 3075088
 Green 3075099

\$0.75 ea
 300 asst., \$0.70 ea
 600 asst., \$0.65 ea



- 4 assorted colors
- 100 per case

100 Case Minimum Order

3070001 \$1.75 ea
 200 asst., or more \$1.65 ea
 400 asst., or more \$1.55 ea

Unisex



Magic Case

3000071 \$2.49 ea
 200 asst., or more \$2.30 ea
 400 asst., or more \$2.15 ea

- Pattern changes depending on which way you open it
- 3 assorted colors per box
- 10 per box - 100 per case

**NEW
PRODUCT**

Retail Bags

Plastic Bags

Two optical designs printed on one side of the bag. Bags are made of durable plastic with a reinforced die-cut handle for easy carrying.

Size: 12" w x 15" h

- 100 bags 44¢/ea
- 500 bags 39¢/ea
- 1,000 bags 34¢/ea

Eye Chart 2990001

Eyeglasses 2990002

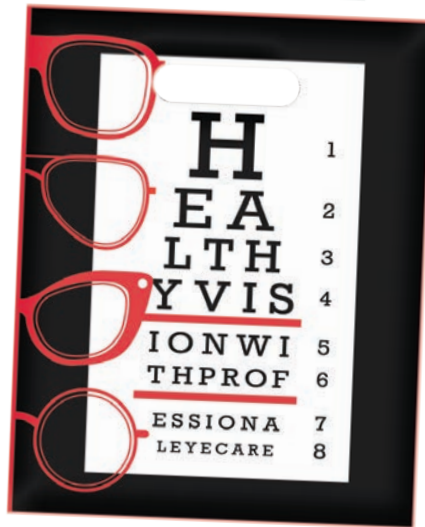

**NEW
PRODUCT**

Frosted Bags

Hi-density frosted plastic bag with matching macramé handle for easy carrying. Reinforced fold-over top and a cardboard bottom insert.

Available in two sizes:

- Small 6" w x 8" h
- Large 8" w x 10" h

6" x 8"

- 100 bags 59¢/ea
- 500 bags 54¢/ea
- 1,000 bags 49¢/ea

8" x 10"

- 100 bags 64¢/ea
- 500 bags 59¢/ea
- 1,000 bags 54¢/ea



White

2991005 6" w x 8" h

2991006 8" w x 10" h

Black

2992005 6" w x 8" h

2992006 8" w x 10" h

Boutique Paper Bags

Narrow Bags

6" w x 8" h x 2.5" d

2992000

100 bags 79¢/ea

500 bags 69¢/ea

1,000 bags 59¢/ea



Wide Bags

8" w x 6" h x 2.5" d

2991000

100 bags 79¢/ea

500 bags 69¢/ea

1,000 bags 59¢/ea



**NEW
PRODUCT**

Retail Bags

Laminated Paper Bags

Bags are matte laminated with a matching macramé handle for easy carrying and a cardboard bottom insert.

Available in four sizes:

- Large Vertical 8" w x 10" h
- Small Vertical 6" w x 8" h
- Large Horizontal 10" w x 8" h
- Small Horizontal 8" w x 6" h

SIZES: 6" x 8" and 8" x 6"

| | |
|------------|--------|
| 100 bags | 86¢/ea |
| 500 bags | 81¢/ea |
| 1,000 bags | 76¢/ea |

SIZES: 8" x 10" and 10" x 8"

| | |
|------------|--------|
| 100 bags | 89¢/ea |
| 500 bags | 84¢/ea |
| 1,000 bags | 79¢/ea |



White

Small Vertical

2991001 6" w x 8" h

Small Horizontal

2991002 8" w x 6" h

Large Vertical

2991003 8" w x 10" h

Large Horizontal

2991004 10" w x 8" h

Black

Small Vertical

2992001 6" w x 8" h

Small Horizontal

2992002 8" w x 6" h

Large Vertical

2992003 8" w x 10" h

Large Horizontal

2992004 10" w x 8" h



Custom Imprinting

Call your sales representative today for details!

3,000 Bag Min. Order

10¢/ea

Allow for 12 week delivery



Stickon Bifocals

Turn Any Pair of Glasses Into Bifocals

- Easily installed and easily adjusted for individual PD measurements
- No cutting needed
- They are Removable and Reusable
- Apply these to Sunglasses, Sports Goggles, Safety Goggles, Dive Masks and more
- Use these for Hunting & Target Shooting, Fishing & Diving



- 3999616 +1.5
- 3999617 +2.0
- 3999618 +2.5
- 3999619 +3.0

\$19.95/ea.

- 12 or more \$17.95/ea.
- 24 or more \$14.95/ea.



Press-On D-Segs and Prisms

3M Press-On Optics provide you with a simple method for creating prismatic and bi-focal corrections. Made of flexible static vinyl, this material is easily cut and fitted to determine if a prescription is working properly. Good adherence, but easily repositioned.

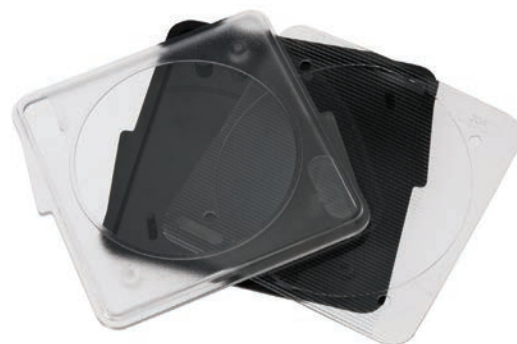

D-Segments \$29.95/per pair

- 3999410 Aspheric D-Seg 1.0 Power
- 3999415 Aspheric D-Seg 1.5 Power
- 3999420 Aspheric D-Seg 2.0 Power
- 3999425 Aspheric D-Seg 2.5 Power
- 3999430 Aspheric D-Seg 3.0 Power
- 3999440 Aspheric D-Seg 4.0 Power
- 3999450 Aspheric D-Seg 5.0 Power
- 3999460 Aspheric D-Seg 6.0 Power

Prisms \$29.95/per lens

- | | | | |
|---------|-------------|---------|------------|
| 3999001 | 1.0 Diopter | 3999010 | 10 Diopter |
| 3999002 | 2.0 Diopter | 3999012 | 12 Diopter |
| 3999003 | 3.0 Diopter | 3999015 | 15 Diopter |
| 3999004 | 4.0 Diopter | 3999020 | 20 Diopter |
| 3999005 | 5.0 Diopter | 3999025 | 25 Diopter |
| 3999006 | 6.0 Diopter | 3999030 | 30 Diopter |
| 3999007 | 7.0 Diopter | 3999035 | 35 Diopter |
| 3999008 | 8.0 Diopter | 3999040 | 40 Diopter |
| 3999009 | 9.0 Diopter | | |



sun lenses





Now You Can Become an Authorized ZEISS Custom Plano Sunglass Store!

Dynamic Labs and lens expert ZEISS Sunlens have joined forces to offer selected optical shops an extraordinary business opportunity.

This program will be **geographically limited**, so secure your authorization today.

Dynamic Labs and ZEISS are looking for optical retail stores that are eager to be a part of this program and to get the most out of it. This is a **great opportunity** for an optical retail store to create a new, **highly profitable and exciting revenue source** while easily implementing this program into its existing infrastructure and adding a new dimension to your current business model.

Three different packages are available for your selection to accommodate whatever level of traffic your business maintains.

If you are interested, call your Dynamic Labs Representative today to find out if you qualify.



Authorized ZEISS Custom Plano Sunglass Store Packages

All Packages Receive:

- 25 different styles
- All promotional material listed (See next column.)
- Certification as an official ZEISS Custom Plano Sunglass Store
- Geographic Exclusivity (Location listed on store locator website.)

Silver Package

5% Discount on this order

(As well as all ZEISS Premium Lens orders within 1 year.)

Initial Purchase: \$1,500

Receive \$1,579 in Merchandise

Gold Package

10% Discount on this order

(As well as all ZEISS Premium Lens orders within 1 year.)

Initial Purchase: \$2,500

Receive \$2,778 in Merchandise

Platinum Package

15% Discount on this order

(As well as all ZEISS Premium Lens orders within 1 year.)

Initial Purchase: \$4,000

Receive \$4,706 in Merchandise



An Authorized ZEISS Custom Sunglass Store Will Receive The Following Promotional Material:

- Lens display box: containing one of every lens in the program
- Counter top display
- Polarized sunglass demonstrator
- Acrylic ZEISS logo block
- Window sticker displaying store as "Authorized ZEISS Custom Sunglass Store"
- Flyers informing customers of the benefits of ZEISS sun lenses

Turn Any Frame You Stock Into The Perfect Pair of Sunglasses

Now you have the opportunity to provide your clientele with these quality lenses in the frames they choose. Whether it's one of the latest, contemporary styles you carry, or a vintage frame they've kept for years, you can satisfy their optical desire through this exclusive program!



Only those lenses that meet our standards are good enough to be engraved with the ZEISS "Z", guaranteeing their authenticity and quality.

Only those lenses become part of the ZEISS Premium Family.

LENSES BY

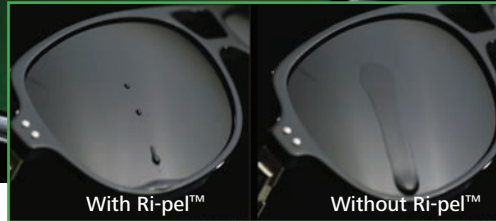

Coating Key

- Ri-pel® Hydrophobic Coating
- Tri-pel® Hydrophobic & Oleophobic
- AR Anti-Reflective Coating

CR-39

Polarized Hard Coat

\$31.05/pr ■ 12+ \$30.05/pr
24+ \$29.05/pr ■ 48+ \$28.05/pr



Grey w/AR Back
7864274 ■ 78-6-2.0



Brown w/AR Back
7864261 ■ 78-6-2.0



Rose w/AR Back
7864273 ■ 78-6-2.0



G-15 w/AR Back
7864271 ■ 78-6-2.0

Polarized Gradient

\$32.12/pr ■ 12+ \$31.12/pr
24+ \$30.12/pr ■ 48+ \$29.12/pr



Grey Gradient w/AR Back
7863374 ■ 78-6-2.0



Brown Gradient w/AR Back
7863361 ■ 78-6-2.0



G-15
7863371 ■ 78-6-1.8

Hard Coat

\$11.38/pr ■ 12+ \$10.38/pr
24+ \$9.88/pr ■ 48+ \$9.38/pr



Grey
7862174 ■ 78-6-1.8



Brown
7862161 ■ 78-6-1.8

Dual Gradient

\$24.59/pr ■ 12+ \$23.59/pr
24+ \$22.59/pr ■ 48+ \$21.59/pr



Grey/Yellow w/AR Back
7866291 ■ 71-6-1.8



Blue/Pink w/AR Back
7866292 ■ 71-6-1.8



SKYLET® Road

Contains a blue filter that offers clear and sharp outdoor vision. Its Color & Contrast Amplifier makes landscapes stand out clearly with richer color and contrast.

CR-39 Skylet® Road Driving Lens

\$16.51/pr ■ 12+ \$15.51/pr
24+ \$15.01/pr ■ 48+ \$14.51/pr



Color & Contrast Amplifier
w/AR Back
7862181 ■ 71-6-1.8





Polarized Poly Injected

\$31.05/pr ■ 12+ \$30.05/pr
24+ \$29.05/pr ■ 48+ \$28.05/pr



Brown w/AR Back
7865261 ■ 55x75-6-2.15



G-15 w/AR Back
7865271 ■ 55x75-6-2.15



Grey w/AR Back
7865274 ■ 55x75-6-2.15

Flash Mirror

\$20.61/pr ■ 12+ \$19.61/pr
24+ \$19.11/pr ■ 48+ \$18.61/pr



Blue on Grey w/AR Back
7865266 ■ 75-6-2.0



Silver on Grey w/AR Back
7865277 ■ 75-6-2.0



Bronze on Grey w/AR Back
7865255 ■ 75-6-2.0



Rose Gold on Grey w/AR Back
7865244 ■ 75-6-2.0

Polarized Flash Mirror

\$36.18/pr ■ 12+ \$35.18/pr
24+ \$34.18/pr ■ 48+ \$33.18/pr



Bronze on Brown w/AR Back
7865288 ■ 55x75-6-2.15



Blue on Grey w/AR Back
7865268 ■ 55x75-6-2.15



Silver on Grey w/AR Back
7865278 ■ 55x75-6-2.15

Polyamide

Nylon-Based Material

Polyamide is ZEISS' proprietary formula for a nylon-based lens material. It offers 100% protection from harmful UV, lens durability, and optical excellence. It is also 50% lighter than glass, making it easier to profile and drill.

Polarized

\$32.12/pr ■ 12+ \$31.12/pr
24+ \$30.12/pr ■ 48+ \$29.12/pr



Grey w/AR Back
7866251 ■ 60x78-6-2.0



Brown w/AR Back
7866252 ■ 60x78-6-2.0

Flash Mirror

\$22.73/pr ■ 12+ \$21.73/pr
24+ \$20.73/pr ■ 48+ \$19.73/pr



Blue Gradient w/AR Back
7866281 ■ 75-6-2.0



Purple Gradient w/AR Back
7866282 ■ 75-6-2.0

ZEISS Lens Coating Features:

- All non-mirrored lens are coated with Ri-pel®, a water & oil repellent, anti-smudge technology developed in ZEISS laboratories. All mirrored lenses are coated with Tri-pel®, a ZEISS formulation that combines Ri-pel with Tri-Flection® Mirror Coating, ZEISS' superior anti-smudge mirror coat.
- All ZEISS Premium lenses come with a ZEISS factory hard coating.

Coating Key

- Ri-pel® Hydrophobic Coating
- Tri-pel® Hydrophobic & Oleophobic
- AR Anti-Reflective Coating



LENSES BY

ZEISS

**NEW
PRODUCT**

DuraVision® BlueProtect

Indoor Solution for Blue Light

How DuraVision BlueProtect works:

ZEISS DuraVision® BlueProtect reflects part of the blueviolet light coming from digital sources, preventing the light from entering the eye. DuraVision also works as an anti-reflective coating. This ZEISS coating reduces the transmission in the spectrum of 380–455 (blue light hazard range) while keeping the high transmission level above 460 nm.

- Since it is applied on clear lenses, the lens is coated by default with the DuraVision Anti-Reflective coating on the backside to guarantee optimal clarity.
- ZEISS coatings blocking part of the blue light spectrum display a blue-violet residual reflection color.
- Easy to clean and water repellent properties.
- Superior scratch resistance and hardness.



Blue-Violet light is partially reflected by ZEISS DuraVision® BlueProtect

BlueProtect
 \$31.05/pr ▪ 12+ \$30.05/pr
 24+ \$29.05/pr ▪ 48+ \$28.05/pr

Clear UV + duraVision BlueProtect front and AR sun back
 7866300 ▪ 76-6-1.8

Iconic Bestsellers From the Number One Name in Vision. **ZEISS**

ZEISS Pre-Moistened Lens Wipes

- Lint and ammonia-free
- Non-abrasive, anti-static
- Gently removes smudges
- 30 wipes/box (12 boxes per case)

Sold by the Case

2961030 **\$3.19/per box**
 5 or more **\$2.95/per box**
 10 or more **\$2.79/per box**



ZEISS Lens Cloth and Spray Cleaning Kit

- Premium Microfiber Cloth
- 2 oz. ZEISS spray lens cleaner
- Gently removes smudges
- 24 kits/box

Sold by the Box

2962222 **\$3.20/per kit**
 10 or more boxes **\$2.99/per kit**
 10 or more boxes **\$2.80/per kit**



Base 6 Polarized Polycarbonate Flash Mirror Lenses

2.0mm, 70x60mm

Reg. \$31.05/pr | 12 or more, \$30.05/pr
24 or more, \$29.05/pr | 48 or more, \$28.05/pr



Silver
7765278

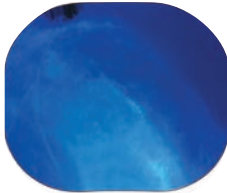

Blue Night
7765268

Base 6 Polarized Polycarbonate Lenses

1.4mm, 70x60mm

Reg. \$17.32/pr | 12 or more, \$16.32/pr
24 or more, \$15.32/pr | 48 or more, \$14.32/pr



True Gray
7703274



True Brown
7703261



G-15
7703271



Yellow
7703262



Amber Rose
7703273

Base 6 Polarized Polycarbonate Lenses with AR Back Coat

1.4mm, 70x60mm

Reg. \$22.73/pr | 12 or more, \$21.73/pr
24 or more, \$20.73/pr | 48 or more, \$19.73/pr



True Gray w/AR
7763274



True Brown w/AR
7763261



G-15 w/AR
7763271

Base 8 Polarized Polycarbonate Lenses

1.4mm, 70x60mm

Reg. \$19.25/pr | 12 or more, \$18.25/pr
24 or more, \$17.25/pr | 48 or more, \$16.25/pr



True Gray
7783274



True Brown
7783261



G-15
7783271

Base 8 Polarized Polycarbonate Lenses with AR Back Coat

1.4mm, 70x60mm

Reg. \$24.59/pr | 12 or more, \$23.59/pr
24 or more, \$22.59/pr | 48 or more, \$21.59/pr



True Gray w/AR
7793274



True Brown w/AR
7793261



G-15 w/AR
7793271

CR-39 Polarized Lenses

2.0mm, 73.5mm dia.

Reg. \$21.55/pr | 12 or more, \$20.55/pr
24 or more, \$19.55/pr | 48 or more, \$18.55/pr

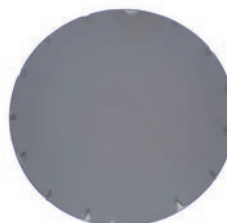

True Gray
7703174

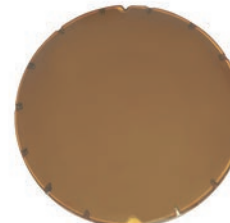

True Brown
7703161

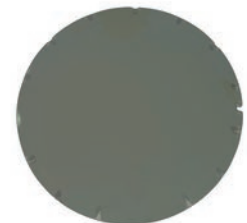

G-15
7703171

Tinted Lenses

Base 6 Polycarbonate

2.0mm, 75mm dia.

Reg. \$4.07/pr | 50 or more, \$3.07/pr | 100 or more, \$2.57/pr



True Gray
7762274



True Brown
7762261



G-15
7762271



Yellow
7762262

Base 6 CR-39 Plano Lenses with UV Protection

2.0mm, 72mm dia.

Reg. \$4.07/pr | 50 or more, \$3.07/pr | 100 or more, \$2.57/pr



Black
7702160



True Gray
7702174



True Brown
7702161



G-15
7702171

CR-39

Base 6 Gradient CR-39 Lenses

1.8mm, 71mm dia.

Reg. \$7.11/pr | 25 or more, \$6.11/pr
50 or more, \$5.11/pr | 100 or more, \$4.11/pr



True Gray
7764174



G-15
7764171



True Brown
7764161

Clear Lenses

Optical Quality

2.0mm, 70mm dia.

Reg. \$3.05/pr | 100 or more, \$2.55/pr | 200 or more, \$2.05/pr



Clear CR-39
7701100



Clear CR-39/ 2.8mm
7701101



Clear Poly
(Non-Tintable)
7763200

Demo Acrylic

2.0mm, 70mm dia.

Reg. \$1.52/pr | 50 or more, \$1.27/pr | 100 or more, \$1.01/pr

* Demo lenses ARE NOT optical quality



Demo* Acrylic
7763100



Think Orange!

LensPRO™
PRECISION

Our New Blocking Pad Will be Your “Go To” Pad
to Eliminate Slippage and Twisting
on Coated and Uncoated Lenses

Go to page 135 for Details

frame parts





Soft, Comfortable HD Silicone™ Nosepads
Are Specifically Designed to Last Longer
Without Discoloring!

FULL BAG 100 Pair 57¢/pair
HALF BAG 50 Pair 70¢/pair
TRIAL BAG 25 Pair 76¢/pair

BUY BULK AND SAVE MORE!

500 Pair 50¢/pair
1,000 Pair 40¢/pair

Symmetrical Nose Pads

Oval



| FULL BAG (100 PAIR) | | |
|---------------------|---------|---------|
| | SNAP | SCREW |
| 11mm | 5111111 | 5111211 |
| 13mm | 5113111 | 5113211 |
| 15mm | 5115111 | 5115211 |
| 17mm | 5117111 | 5117211 |

| HALF BAG (50 PAIR) | | |
|--------------------|---------|---------|
| | SNAP | SCREW |
| 11mm | 5111115 | 5111215 |
| 13mm | 5113115 | 5113215 |
| 15mm | 5115115 | 5115215 |
| 17mm | 5117115 | 5117215 |

| TRIAL BAG (25 PAIR) | | |
|---------------------|---------|---------|
| | SNAP | SCREW |
| 11mm | 5111112 | 5111212 |
| 13mm | 5113112 | 5113212 |
| 15mm | 5115112 | 5115212 |
| 17mm | 5117112 | 5117212 |

Teardrop



| FULL BAG (100 PAIR) | | |
|---------------------|---------|---------|
| | SNAP | SCREW |
| 13mm | 5613111 | 5613211 |
| 15mm | 5615111 | 5615211 |
| 17mm | 5617111 | 5617211 |
| 19mm | 5619111 | 5619211 |

| HALF BAG (50 PAIR) | | |
|--------------------|---------|---------|
| | SNAP | SCREW |
| 13mm | 5613115 | 5613215 |
| 15mm | 5615115 | 5615215 |
| 17mm | 5617115 | 5617215 |
| 19mm | 5619115 | 5619215 |

| TRIAL BAG (25 PAIR) | | |
|---------------------|---------|---------|
| | SNAP | SCREW |
| 13mm | 5613112 | 5613212 |
| 15mm | 5615112 | 5615212 |
| 17mm | 5617112 | 5617212 |
| 19mm | 5619112 | 5619212 |

Round



| FULL BAG (100 PAIR) | | |
|---------------------|---------|---------|
| | SNAP | SCREW |
| 9mm | 5209111 | 5209211 |
| 11mm | 5211111 | 5211211 |

| HALF BAG (50 PAIR) | | |
|--------------------|---------|---------|
| | SNAP | SCREW |
| 9mm | 5209115 | 5209215 |
| 11mm | 5211115 | 5211215 |

| TRIAL BAG (25 PAIR) | | |
|---------------------|---------|---------|
| | SNAP | SCREW |
| 9mm | 5209112 | 5209212 |
| 11mm | 5211112 | 5211212 |



Strap Bridge



Snap Style



Screw Style

\$17.96/pkg
12 pkgs or more \$15.96/pkg

| 10 PIECES | | |
|-----------|---------|---------|
| | SNAP | SCREW |
| 20mm | 5420118 | 5420218 |
| 30mm | 5430118 | 5430218 |
| 36mm | 5436118 | 5436218 |

Softwing



Silver



Gold

\$17.38/pkg
12 pkgs or more \$16.38/pkg

| 3 PIECES | | |
|----------|---------|---------|
| | SILVER | GOLD |
| 15mm | 5315753 | 5315763 |
| 17mm | 5317753 | 5317763 |

4012321 Softwing Screw \$12.95

D-Shaped Symmetrical



Snap Style



Screw Style

| FULL BAG (100 PAIR) | | |
|---------------------|---------|---------|
| | SNAP | SCREW |
| 13mm | 5013111 | 5013211 |
| 15mm | 5015111 | 5015211 |
| 17mm | 5017111 | 5017211 |
| 19mm | 5019111 | 5019211 |

| HALF BAG (50 PAIR) | | |
|--------------------|---------|---------|
| | SNAP | SCREW |
| 13mm | 5013115 | 5013215 |
| 15mm | 5015115 | 5015215 |
| 17mm | 5017115 | 5017215 |
| 19mm | 5019115 | 5019215 |

| TRIAL BAG (25 PAIR) | | |
|---------------------|---------|---------|
| | SNAP | SCREW |
| 13mm | 5013112 | 5013212 |
| 15mm | 5015112 | 5015212 |
| 17mm | 5017112 | 5017212 |
| 19mm | 5019112 | 5019212 |

PrimaDonna

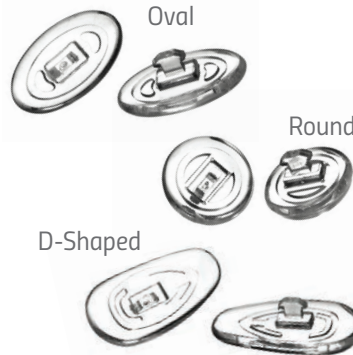

Oval

Round

D-Shaped

| FULL BAG (100 PAIR) | | |
|---------------------|---------|----------|
| | | SHAPE |
| 9mm | 5209411 | Round |
| 13mm | 5113411 | Oval |
| 15mm | 5015411 | D-Shaped |
| 17mm | 5017411 | D-Shaped |

| HALF BAG (50 PAIR) | | |
|--------------------|---------|----------|
| | | SHAPE |
| 9mm | 5209415 | Round |
| 13mm | 5113415 | Oval |
| 15mm | 5015415 | D-Shaped |
| 17mm | 5017415 | D-Shaped |

| TRIAL BAG (25 PAIR) | | |
|---------------------|---------|----------|
| | | SHAPE |
| 9mm | 5209412 | Round |
| 13mm | 5113412 | Oval |
| 15mm | 5015412 | D-Shaped |
| 17mm | 5017412 | D-Shaped |

A/T Base Mushroom

Use On Airlock Frames



Oval

Round

| FULL BAG (100 PAIR) | | |
|---------------------|---------|-------|
| | | SHAPE |
| 9mm | 5209311 | Round |
| 12mm | 5112311 | Oval |

| HALF BAG (50 PAIR) | | |
|--------------------|---------|-------|
| | | SHAPE |
| 9mm | 5209315 | Round |
| 12mm | 5112315 | Oval |

| TRIAL BAG (25 PAIR) | | |
|---------------------|---------|-------|
| | SNAP | SCREW |
| 9mm | 5209312 | Round |
| 12mm | 5112312 | Oval |



Air-Active®

Introducing High-Comfort Air Cushioning

A new type of nose pad with even more wearing comfort than regular silicone pads. In addition to the benefits offered by pads made of silicone, an air cushion system makes this pad even more comfortable to wear.

5 PAIR PACKAGES

| | SNAP | SCREW |
|------|---------|---------|
| 11mm | NA | 5012115 |
| 13mm | 5012135 | NA |
| 15mm | 5012155 | 5012515 |

25 PAIR PACKAGES

| | SNAP | SCREW |
|------|----------|----------|
| 11mm | NA | 50121125 |
| 13mm | 50121325 | NA |
| 15mm | 50121525 | 50122515 |

5 Pair/Package \$19.95/pkg
 25 Pair/Package \$74.95/pkg

Trimnable Adhesive Silicone Nosepads



19mm D shape that can be trimmed to any size. For plastic frames.

- Helps prevent slipping
- Clear soft silicone adds an extra cushion on the nose
- One size fits all
- 36 pair/pkg.

5019003 \$34.95/pkg
 5 pkgs or more \$29.95/pkg
 10 pkgs or more \$24.95/pkg

Ray-Ban Style Crimp-On Nosepads

Hard Acetate with Silver Insert



PACKAGES

| | 10 pkg | 25 pkg |
|------|---------|---------|
| 12mm | 5612610 | 5612612 |
| 14mm | 5614610 | 5614612 |
| 16mm | 5616610 | 5616612 |

10 Pair Package \$11.14/pkg
 25 Pair Package \$23.41/pkg



Hypo-Allergenic Semi-Soft Vinyl Nosepads

A Great Alternative for Patients with Silicone Allergies!

Symmetrical Nose Pads

Round



| FULL BAG (100 PAIR) | | |
|---------------------|---------|---------|
| | SNAP | SCREW |
| 9mm | 5209131 | 5209231 |

| HALF BAG (50 PAIR) | | |
|--------------------|---------|---------|
| | SNAP | SCREW |
| 9mm | 5209135 | 5209235 |

| TRIAL BAG (25 PAIR) | | |
|---------------------|---------|---------|
| | SNAP | SCREW |
| 9mm | 5209132 | 5209232 |

Oval



| FULL BAG (100 PAIR) | | |
|---------------------|---------|---------|
| | SNAP | SCREW |
| 13mm | 5113131 | 5113231 |

| HALF BAG (50 PAIR) | | |
|--------------------|---------|---------|
| | SNAP | SCREW |
| 13mm | 5113135 | 5113235 |

| TRIAL BAG (25 PAIR) | | |
|---------------------|---------|---------|
| | SNAP | SCREW |
| 13mm | 5113132 | 5113232 |

Teardrop



| FULL BAG (100 PAIR) | | |
|---------------------|---------|---------|
| | SNAP | SCREW |
| 13mm | 5613131 | 5613231 |
| 15mm | 5615131 | 5615231 |
| 17mm | 5617131 | 5617231 |

| HALF BAG (50 PAIR) | | |
|--------------------|---------|---------|
| | SNAP | SCREW |
| 13mm | 5613135 | 5613235 |
| 15mm | 5615135 | 5615235 |
| 17mm | 5617135 | 5617235 |

| TRIAL BAG (25 PAIR) | | |
|---------------------|---------|---------|
| | SNAP | SCREW |
| 13mm | 5613132 | 5613232 |
| 15mm | 5615132 | 5615232 |
| 17mm | 5617132 | 5617232 |

D-Shaped



| FULL BAG (100 PAIR) | | |
|---------------------|---------|---------|
| | SNAP | SCREW |
| 15mm | 5015131 | 5015231 |
| 17mm | 5017131 | 5017231 |
| 19mm | 5019131 | 5019231 |

| HALF BAG (50 PAIR) | | |
|--------------------|---------|---------|
| | SNAP | SCREW |
| 15mm | 5015135 | 5015235 |
| 17mm | 5017135 | 5017235 |
| 19mm | 5019135 | 5019235 |

| TRIAL BAG (25 PAIR) | | |
|---------------------|---------|---------|
| | SNAP | SCREW |
| 15mm | 5015132 | 5015232 |
| 17mm | 5017132 | 5017232 |
| 19mm | 5019132 | 5019232 |

| | | |
|-----------|----------|----------|
| FULL BAG | 100 Pair | 57¢/pair |
| HALF BAG | 50 Pair | 70¢/pair |
| TRIAL BAG | 25 Pair | 76¢/pair |

BUY BULK AND SAVE MORE!

| | |
|------------|----------|
| 500 Pair | 50¢/pair |
| 1,000 Pair | 40¢/pair |

Ultra-Thin Polycarbonate Nosepads

Thin, Light Weight Nosepads That Are Ideal For Smaller Frames

Symmetrical Polycarbonate "M" Nose Pads

| | | |
|-----------|----------|----------|
| FULL BAG | 100 Pair | 57¢/pair |
| HALF BAG | 50 Pair | 70¢/pair |
| TRIAL BAG | 25 Pair | 76¢/pair |

BUY BULK AND SAVE MORE!

| | |
|------------|----------|
| 500 Pair | 50¢/pair |
| 1,000 Pair | 40¢/pair |

Round



| FULL BAG (100 PAIR) | | |
|---------------------|---------|---------|
| | SNAP | SCREW |
| 9mm | 5209121 | 5209221 |

| HALF BAG (50 PAIR) | | |
|--------------------|---------|---------|
| | SNAP | SCREW |
| 9mm | 5209125 | 5209225 |

| TRIAL BAG (25 PAIR) | | |
|---------------------|---------|---------|
| | SNAP | SCREW |
| 9mm | 5209122 | 5209222 |

Oval



| FULL BAG (100 PAIR) | | |
|---------------------|---------|---------|
| | SNAP | SCREW |
| 13mm | 5113121 | 5113221 |

| HALF BAG (50 PAIR) | | |
|--------------------|---------|---------|
| | SNAP | SCREW |
| 13mm | 5113125 | 5113225 |

| TRIAL BAG (25 PAIR) | | |
|---------------------|---------|---------|
| | SNAP | SCREW |
| 13mm | 5113122 | 5113222 |

Nosepad Tools

Additional information and choices in our "Tools" section. (Page 87)



Euro-Style Nosepad Adjusting Pliers

Grooved jaw fits around pad box for a sure grip.

| | |
|-----------|---------|
| 6140016 | \$34.95 |
| 6 or more | \$29.95 |



Push-in Nosepad Removal Pliers

Put the forked jaw between nosepad and box and use the other jaw to pop nosepad right out!

| | |
|-----------|---------|
| 6140048 | \$34.95 |
| 6 or more | \$29.95 |



Nosepad Popper

Quickly remove nosepads with this simple tool!

| | |
|---------|---------|
| 6210048 | \$12.95 |
|---------|---------|

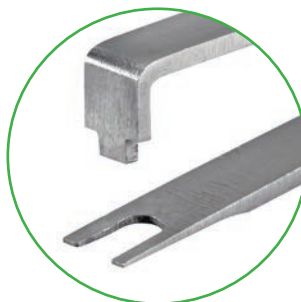

Nosepad Tweezer

Quickly remove nosepads with this simple tool!

| | |
|---------|---------|
| 6210049 | \$20.85 |
|---------|---------|



These HD Silicone Kits Are a Great Way to Keep Your Nosepads Organized

Symmetrical Nose Pad Kits



Football

- 25 pairs each screw and snap styles
- Sizes: 13mm, 15mm, 17mm, 19mm
- 25 pairs 12mm "Mushroom"
- 100 screws

5501510 **\$113.95**



Vinyl Polycarbonate

- 25 pairs each Semi-Soft Vinyl Teardrop 13mm, 15mm & 17mm snap in and screw in
- 25 pairs each Semi-Soft Vinyl 9mm snap in and screw in
- 25 pairs each Polycarbonate Football 13mm snap in and screw in
- 100 screws

5502521 **\$102.95**



Teardrop

- 25 pairs each screw and snap styles
- Sizes: 13mm, 15mm, 17mm, 19mm
- 100 screws

5501511 **\$113.95**



Round Polycarb, Vinyl and HD Silicone Kit

- 25 pairs each HD Silicone 9mm & 11mm screw style & snap style
- 25 pairs each Polycarbonate 9mm snap-in and screw-in with screws
- 25 pairs each Semi-Soft Vinyl 9mm snap in and screw-in with screws
- 25 pairs each HD Silicone 9mm "Mushroom" A/T base
- 100 screws

5502522 **\$113.95**



Master D Kit

- 25 pairs each screw and snap styles
- Sizes: 13mm, 15mm, 17mm, 19mm
- 100 screws

5501509 **\$102.95**



Master One-Piece Kit

- 3 pieces each HD Silicone Softwings: 15mm and 17mm Silver for Metal 15mm and 17mm Gold for Metal
- 10 pieces each HD Silicone Strapbridges: 20mm, 30mm & 36mm snap & screw
- 100 screws
- 100 Softwing screws

5502520 **\$133.95**

Screws

100 Screws Per Vial

All Our Screws Feature **Dynalock™ Coating** to Stay in Place

 Most commonly used sizes

Self-Aligning Screws

Ideal for spring hinge frames! Our standard self-aligning screws have a special pointed end that is scored so it snaps off easily once inserted and tightened.

\$29.95/Vial 5 or more \$27.95/vial 10 or more \$25.95/vial



| LENGTH | HEAD | DIAMETER | SILVER PHILLIPS | SILVER SLOTTED | GOLD SLOTTED | BLACK SLOTTED |
|--------|-------|----------|-----------------|----------------|--------------|---------------|
| 3.5mm | 2.0mm | 1.2mm | 4012355 | 4012352 | 4112352 | 4212352 |
| 4.3mm | | 1.3mm | 4013435 | 4013432 | 4113432 | 4213432 |
| | | 1.4mm | 4014435 | 4014432 | 4114432 | 4214432 |
| | | 1.5mm | 4015435 | 4015432 | 4115432 | 4215432 |

Hinge Finder Screws

Ideal for spring hinge frames! Our hinge finder screws have pointed ends as well, but are hollow to allow themselves to be broken off or trimmed very easily just about anywhere along the length of the screw.

\$29.95/Vial 5 or more \$27.95/vial 10 or more \$25.95/vial



| LENGTH | HEAD | DIAMETER | SILVER PHILLIPS | SILVER SLOTTED | GOLD SLOTTED | BLACK SLOTTED |
|--------|-------|----------|-----------------|----------------|--------------|---------------|
| 6.4mm | 2.0mm | 1.2mm | 4012645 | 4012642 | 4112642 | 4212642 |
| | | 1.3mm | 4013645 | 4013642 | — | — |
| | | 1.4mm | 4014645 | 4014642 | 4114642 | 4214642 |
| | | 1.5mm | 4015645 | 4015642 | — | — |

Self-Tapping Screws

Stainless steel self-tapping screws for all types of quick and easy repairs. No special tools needed, simply screw them in and they renew worn or stripped threads as they go!

\$29.95/Vial 5 or more \$27.95/vial 10 or more \$25.95/vial



| LENGTH | HEAD | DIAMETER | SILVER PHILLIPS | SILVER SLOTTED | GOLD PHILLIPS | GOLD SLOTTED | BLACK PHILLIPS | BLACK SLOTTED |
|--------|-------|----------|-----------------|----------------|---------------|--------------|----------------|---------------|
| 11.4mm | 2.0mm | 1.2mm | 4012115 | 4012112 | — | 4112112 | — | 4212112 |
| | | 1.3mm | 4013115 | 4013112 | — | 4113112 | — | 4213112 |
| | | 1.4mm | 4014115 | 4014112 | — | 4114112 | — | 4214112 |
| | | 1.5mm | 4015115 | 4015112 | — | 4115112 | — | 4215112 |
| 11.4mm | 2.5mm | 1.2mm | — | — | — | — | — | 4212113 |
| | | 1.3mm | — | 4013113 | — | 4113113 | — | 4213113 |
| | | 1.4mm | — | 4014113 | 4114115 | 4114113 | 4214115 | 4214113 |
| | | 1.5mm | — | 4015113 | — | 4115113 | — | 4215113 |
| | | 1.6mm | — | 4016113 | — | 4116113 | — | — |
| | | 1.7mm | — | 4017113 | — | 4117113 | — | — |



Screws

100 Screws Per Vial

All Our Screws Feature **Dynalock™ Coating** to Stay in Place

 Most commonly used sizes

Sleeved Screws (Eyewire & Hinge)

\$29.95/Vial 5 or more \$27.95/vial 10 or more \$25.95/vial

The sleeves on these screws lock them firmly in place and prevent them from backing out.



| LENGTH | HEAD | DIAMETER | SILVER PHILLIPS SLEEVED EYEWIRE | SILVER SLOTTED SLEEVED EYEWIRE | SILVER PHILLIPS SLEEVED HINGE | SILVER SLOTTED SLEEVED HINGE |
|--------|-------|----------|---------------------------------|--------------------------------|-------------------------------|------------------------------|
| 4.35mm | 2.0mm | 1.4mm | 4014535 | 4014434 | — | — |
| 4.0mm | 2.0mm | 1.4mm | — | — | 4014505 | 4014404 |

Eyewire Screws

\$12.95/Vial 5 or more \$10.95/vial 10 or more \$8.95/vial

Popular sizes in three colors to suit most frame finishes. Use as direct replacement for original manufacturer's hardware.

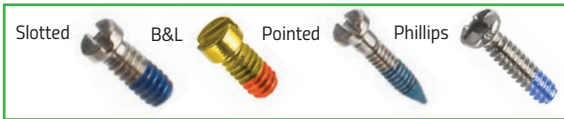

| LENGTH | HEAD | DIAMETER | STYLE | SILVER | GOLD | BLACK |
|--------|-------|----------|---------------|---------|---------|---------|
| 4.4mm | 1.8mm | 1.2mm | Slotted | 4012441 | 4112441 | 4212441 |
| 3.5mm | 1.8mm | 1.37mm | Slotted B & L | 4013351 | 4113351 | 4213351 |
| 3.0mm | 1.9mm | 1.4mm | Slotted | 4014302 | 4114302 | 4214302 |
| 3.8mm | 1.8mm | 1.4mm | Pointed | 4014386 | 4114386 | 4214386 |
| 3.8mm | 1.9mm | 1.4mm | Slotted | 4014381 | 4114381 | 4214381 |
| 3.8mm | 2.0mm | 1.4mm | Phillips | 4014385 | 4114385 | — |
| 4.4mm | 1.8mm | 1.4mm | Slotted | 4014441 | 4114441 | 4214441 |
| 5.2mm | 1.9mm | 1.4mm | Slotted | 4014522 | 4114522 | 4214522 |

Hinge Screws

\$12.95/Vial 5 or more \$10.95/vial 10 or more \$8.95/vial

We have a broad selection of the most popular manufacturer's sizes, for a direct replacement of the original parts in most cases. Long-wearing stainless steel.



| LENGTH | HEAD | DIAMETER | SILVER PHILLIPS | SILVER SLOTTED | SILVER POINTED | GOLD PHILLIPS | GOLD SLOTTED | BLACK SLOTTED |
|--------|-------|----------|-----------------|----------------|----------------|---------------|--------------|---------------|
| 4.4mm | 2.0mm | 1.4mm | 4014445 | 4014442 | 4014446 | 4114445 | 4114442 | 4214442 |
| 5.0mm | 2.0mm | 1.4mm | — | 4014502 | — | — | — | — |
| 6.2mm | 2.0mm | 1.4mm | — | 4014622 | — | — | — | — |
| 5.8mm | 2.5mm | 1.6mm | — | 4016583 | — | — | — | — |
| 6.0mm | 2.0mm | 1.7mm | — | — | — | — | 4117602 | — |
| 9.0mm | 2.5mm | 1.7mm | — | 4017903 | — | — | — | — |

Screws

100 Screws Per Vial

All Our Screws Feature **Dynalock™ Coating** to Stay in Place

 Most commonly used sizes



Nosepad Screws

Great for all types of nosepads!
Hypo-allergenic stainless steel
won't corrode or loosen!

\$12.95/Vial 5 or more **\$10.95/vial** 10 or more **\$8.95/vial**



| LENGTH | HEAD | DIAMETER | SILVER PHILLIPS | SILVER SLOTTED | SILVER POINTED | GOLD PHILLIPS | GOLD SLOTTED | GOLD POINTED |
|--------|-------|--------------|-----------------|----------------|----------------|---------------|--------------|--------------|
| 4.1mm | 1.4mm | 1.0mm | 4010415 | 4010411 | 4010416 | 4110415 | 4110411 | 4110416 |

| | | | | | | | | |
|-------|-------|--------------|---|--------------------|--|---|---|---|
| 5.5mm | 1.4mm | 1.1mm | — | 4011551 (X-Long) |  | — | — | — |
| 3.2mm | 1.8mm | 1.2mm | — | 4012321 (Softwing) |  | — | — | — |

Rimless Trim Screws

So named because they were made to be trimmed to length. Used with matching nuts for screw mounted rimless frames. Simply match the screw diameter with the nut diameter for the perfect fit every time!

Slotted: \$12.95/Vial 5 or more **\$10.95/vial** 10 or more **\$8.95/vial**
Hexagonal: \$20.95/Vial 5 or more **\$18.95/vial** 10 or more **\$17.95/vial**



| LENGTH | HEAD | DIAMETER | SILVER SLOTTED | GOLD SLOTTED | BLACK SLOTTED | SILVER HEXAGONAL | GOLD HEXAGONAL | BLACK HEXAGONAL |
|--------|-------|---------------|----------------|--------------|---------------|------------------|----------------|-----------------|
| 9.4mm | 2.0mm | 1.16mm | 4011092 | 4111092 | — | — | — | — |
| 9.4mm | | 1.2mm | 4012093 | 4112093 | — | — | — | — |
| 9.4mm | | 1.3mm | 4013093 | 4113092 | — | — | — | — |
| 10.0mm | 2.5mm | 1.4mm | 4014103 | 4114103 | 4214103 | — | — | — |
| 10.6mm | | 1.2mm | — | — | — | 4012116 | 4112116 | 4212116 |
| 10.6mm | | 1.4mm | — | — | — | 4014116 | 4114116 | 4214116 |

Cap or Acorn Nuts

Acorn or cap nuts feature a rounded top to prevent the end of the screw from protruding. They come in all the same sizes and colors as our standard hex nuts plus a clear plastic version. Most outside diameters are 2.5mm. Great for putting the finishing touch on a rimless job!

\$24.95/Vial 5 or more **\$22.95/vial** 10 or more **\$20.95/vial**



| INSIDE DIAMETER | SILVER | GOLD | BLACK | CLEAR PLASTIC |
|-----------------|---------|---------|---------|---------------|
| 1.16mm | 4411221 | 4411222 | — | — |
| 1.2mm | 4412221 | 4412222 | — | — |
| 1.3mm | 4413251 | 4413252 | — | — |
| 1.4mm | 4414221 | 4414222 | 4414223 | 4414254 |

Hex Nuts

Hex nuts available in matching sizes and colors to match the screws. Outside diameter is 2.5mm.

\$12.95/Vial

5 or more **\$10.95/vial** 10 or more **\$8.95/vial**



| INSIDE DIAMETER | SILVER | GOLD | BLACK |
|-----------------|---------|---------|---------|
| 1.16mm | 4311221 | 4311222 | — |
| 1.2mm | 4312221 | 4312222 | 4312223 |
| 1.3mm | 4313251 | 4313252 | — |
| 1.4mm | 4314251 | 4314252 | 4314253 |

Washers

Our clear plastic flat washers are crystal clear. Our standard metal washers come in three colors and two sizes to fit just about any need you may have. All are .45mm thick.

\$12.95/Vial 5 or more **\$10.95/vial** 10 or more **\$8.95/vial**



| INSIDE DIAMETER | OUTSIDE DIAMETER | SILVER | GOLD | BLACK | CLEAR PLASTIC |
|-----------------|------------------|---------|---------|---------|---------------|
| 1.2mm | 2.5mm | 4512101 | 4512102 | — | 4512104 |
| 1.4mm | 2.8mm | 4514101 | 4514102 | 4514103 | 4515104 |



Rimless Bushings

Our pressure mount bushings can be used on most manufacturer's frames.

Get OEM quality at generic prices!

Double Pin
Silhouette Style



| Outside Diameter | Inside Diameter | Length 7.0mm | Item # |
|------------------|--------------------------|--------------|---------|
| 1.4mm | Legs are 3.0mm on center | | 4508027 |
| 1.5mm | | | 4508028 |
| 1.6mm | | | 4508029 |
| 1.8mm | | | 4508030 |
| 2.0mm | NEW | | 4508039 |

\$20.95/Vial 100 per vial
5 or more **\$18.95/vial** 10 or more **\$16.95/vial**

Double Pin Soft
Silhouette Style



| Outside Diameter | Inside Diameter | Length 7.0mm | Item# |
|------------------|--------------------------|--------------|-----------|
| 1.4mm | Legs are 3.0mm on center | | 4508027-S |
| 1.5mm | | | 4508028-S |
| 1.6mm | | | 4508029-S |
| 1.8mm | | | 4508030-S |

\$20.95/Vial 100 per vial
5 or more **\$18.95/vial** 10 or more **\$16.95/vial**

Silhouette SPX Style



Marchon Air Lock Style



| Outside Diameter | Inside Diameter | Length | Item# |
|------------------|-----------------|--------|---------|
| 2.2mm | 1.35mm | 7.5mm | 4508025 |

\$30.95/Vial 100 per vial
5 or more **\$28.95/vial** 10 or more **\$26.95/vial**

Kawasaki Style



| Outside Diameter | Inside Diameter | Length | Item# |
|------------------|-----------------|--------|---------|
| 1.8mm | 1.35mm | 7.5mm | 4508038 |

\$30.95/Vial 100 per vial
5 or more **\$28.95/vial** 10 or more **\$26.95/vial**

Aspex Style



| Outside Diameter | Inside Diameter | Length | Item# |
|------------------|--------------------------|--------|---------|
| 1.8mm | Legs are 3.5mm on center | | 4508031 |

\$30.95/Vial 100 per vial
5 or more **\$28.95/vial** 10 or more **\$26.95/vial**

Single Pin Compression Bushing



| Outside Diameter | Inside Diameter | Length | Item# |
|------------------|-----------------|--------|---------|
| 1.4mm | 0.8mm | 7.0mm | 4508026 |

\$20.95/Vial 100 per vial
5 or more **\$18.95/vial** 10 or more **\$16.95/vial**

Top Hat Bushing



| Brim Diameter | Outside Diameter | Length | Item# |
|---------------|------------------|--------|---------|
| 2.5mm | 1.2mm | 7.0mm | 4512205 |
| 3.0mm | 1.4mm | 7.0mm | 4514205 |

\$12.95/Vial 100 per vial
5 or more **\$10.95/vial** 10 or more **\$8.95/vial**

Lens Liners and Cords

Lens Liners

Nylon

1.2mm – 4 yards per roll
7260120 \$6.50 ea.

1.4mm – 4 yards per roll
7270140 \$6.50 ea.

Regular Acetate

1 meter roll
7360120 \$9.95 ea.

Heavy Acetate

1 meter roll
7360140 \$9.95 ea.

Liquid Interliner

7370150 \$12.95



Semi-Rimless Cords

Replacement nylon liner for semi-rimless frames.

Rimless Bottom Cord

50 ft
7245501 \$6.95 ea.

Eyewire Top Replacement Cords

Small Figure 8 – 1 meter roll
7248551 \$5.95 ea.

Large Figure 8 – 1 meter roll
7250601 \$5.95 ea.

T-shaped – 1 meter roll
7248561 \$5.95 ea.



Adhesives and Cements

Lindberg UV Curable Adhesive

- 10ml per tube
- 2 Tube Minimum



1 Tube
1103096 \$49.95

10 Tube pkg
1103095 \$415.95

Loctite 4851 Flexible Instant Adhesive

- Suitable for Lindberg frames
- 20 gm bottle

1104851 \$64.95/ea



Adhesive Dispensing Tips

- For controlled dispensing of eyeglass adhesives
- Suitable for Lindberg syringes
- 50 per pack

1102250 \$49.95



10mL Dispenser for UV Curable Adhesive

Plunger style Dispenser

1 Plunger
1103097 \$12.95



Future Glue

- Works through dirt and oils!
- No cleaning necessary prior to use
- 2g tube

1101002 \$4.95/ea



Lens Grip

- Double-sided adhesive tape
- 50 foot roll

7200050 \$12.95

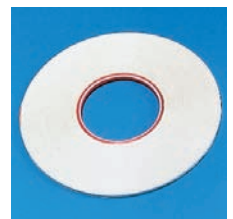

Optical Screw Locker

- Standard cyanoacrylate based liquid screw locker
- Two 3g bottles

1101373 \$11.95/ea
4 or more \$9.95/ea



Hi-Tension Screw Locker

- Prevents screws from backing out
- Will not craze most polycarbonate lenses
- 6mL bottle

1100950 \$10.95/ea

4 or more \$9.95/ea



GS Crystal Cement



- Designed for use on clear plastics
- With wire applicator
- 1/3 fl. oz. tube

1101303 \$7.95/ea



Screw and Component Kits

A Great Way to Keep Your Inventory Organized

Silver Starter Screw Kit

Contains 50 each of the following:

- Trim screws with matching hex nuts, clear washers, top hat bushings and acorn nuts
- Eyewire screws, 1.4mm
- Hinge finder screws, 1.4mm
- Hinge screws, 1.4mm and 1.7mm
- Nosepad screws, 1.0mm and 1.2mm



600 Total Pieces 4600001 \$82.95

Self-Aligning Spring Hinge Kit

Contains 50 each of the following:

- Self-aligning Silver, Gold, 1.4mm x 4.3mm
- Self-aligning Silver, Gold, 1.3mm x 4.3mm
- Self-aligning Silver, Gold, 1.2mm x 3.5mm
- Hinge Finder Silver, Gold, Gun Metal, 1.4mm x 6.4mm
- Hinge Finder Silver, Gold, Gun Metal, 1.2mm x 6.4mm



600 Total Pieces 4600005 \$102.95

Silver Self-Tapping Screw Kit

Contains 50 each of the following:

- Small head self-tapping screws, 1.2, 1.3, 1.4 and 1.5mm
- Large head self-tapping screws, 1.4, 1.5 and 1.7mm
- Hinge Finder, 1.4mm x 6.4mm
- Hinge Finder, 1.2mm x 6.4mm

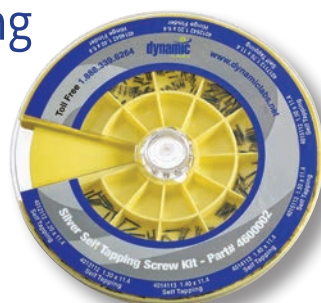

450 Total Pieces 4600002 \$102.95

Gold Self-Tapping Screw Kit

Contains 50 each of the following:

- Small head self-tapping screws, 1.2, 1.3, 1.4 and 1.5mm
- Large head self-tapping screws, 1.4, 1.5 and 1.7mm
- Hinge Finder, 1.4mm x 6.4mm
- Hinge Finder, 1.2mm x 6.4mm

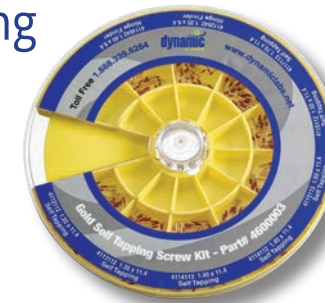

450 Total Pieces 4600003 \$102.95

Matching Screws, Nuts & Washers Kit

Contains 50 each of the following:

- Silver and gold trim screws, 1.16mm and 1.4mm
- Silver and gold metal washers, hex nuts and acorn nuts, 1.16mm and 1.4mm
- Clear top-hat bushings and washers, 1.4mm x 6.4mm

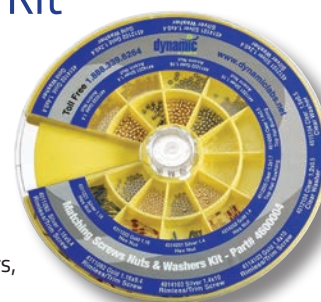

900 Total Pieces 4600004 \$133.95

Round 20-Space Wheel Organizer

9210520 **\$9.95**

5 or more **\$8.95**

10 or more **\$7.95**



Bushing & Rimless Tools

Rimless Compression Mount Pliers



6130013 \$34.95/ea
6 or more \$29.95/ea

Rimless Bushing Pulling Pliers



6130012 \$34.95/ea
6 or more \$29.95/ea

Rimless Bushing Cutting Pliers



6130011 \$34.95/ea
6 or more \$29.95/ea

Thin Bushing Cutting Pliers



6130313 \$36.95/ea
6 or more \$31.95/ea

Bushing Pushing Pliers



6130014 \$34.95/ea
6 or more \$29.95/ea

Rimless Chamfering Tool



- Simple way to file rough edges around the hole in drilled rimless glasses
- Creates a smooth countersunk finish that helps prevent spidering and cracking

5999902 \$29.95/ea

Replacement Tip

6277040 \$8.95/ea

Reach Nuts

Designed to eliminate the need for through bushings on screw mount rimless frames.

- All lengths are 4.0mm long
- Tighten them up, cut off the end of the screw and file it flat for a neat clean look
- Our reach nuts are compatible with wrench #6440025



| Inside Diameter | Outside Diameter | Silver | Gold |
|-----------------|------------------|---------|---------|
| 1.2mm | 2.5mm | 4412251 | 4412252 |
| 1.4mm | 2.5mm | 4414251 | 4414252 |

\$24.95/pkg 5 or more \$22.95/pkg 10 or more \$20.95/pkg

Rimless Mounting Tool

Use this simple hook to insert lenses in semi-rimless frames effortlessly.



6218001 \$4.95/ea

Replacement Hooks-3 pkg

6218002 \$4.95/ea



Universal Measuring Disc

No need to fuss with trying to find the right screw. Use the Universal Measuring Disc to easily find what screw to use. Measures frame screw hole sizes from 1.0mm to 2.2mm.

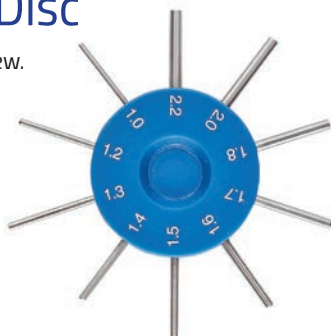

6635175 \$20.95

Screw & Component Organizers

24-Drawer Component Organizer

- 6.25" deep 15.5" high and 19.75" wide
- Comes with dividers

9210524 \$79.95



6-Component Organizer

- Measures 8.5" x 4.5" x 1.5"
- Comes with dividers

9210506 \$9.95



Multi-Compartment Organizer

- 11" x 7.5" x 2"
- Create up to 36 compartments

9210518 \$12.95



Extra Dividers

9210702 \$10.95/6 pack

Non-Slip Frame Tags

- Stays in place and keep display neat
- Excellent for bar codes
- Long lasting
- Reusable



Slip On Size: 3/4" x 2 1/16" \$119.95/bag



Non Slip Size: 11/16" x 2" \$129.95/bag

| STYLE | PKG QTY | WHITE | LT BLUE |
|----------|---------|---------|---------|
| Slip On | 1000 | 5970710 | 5970711 |
| Non Slip | 1000 | 5970708 | 5970709 |



Not actual size

| SIZE | PKG QTY | WHITE | YELLOW |
|-------|---------|---------|---------|
| Small | 1000 | 5970701 | 5970703 |
| Large | 500 | 5970705 | 5970707 |

\$14.95/package

Self-Closing Tweezers

Holds the screw when you release your grip!

6057739 \$12.95/ea

6 or more \$9.95/ea



Screw Holding Tweezers

Handy for close, small work at the bench.

6057730 \$7.95/ea

6 or more \$6.95/ea



Silicone Conversion Cable Ends

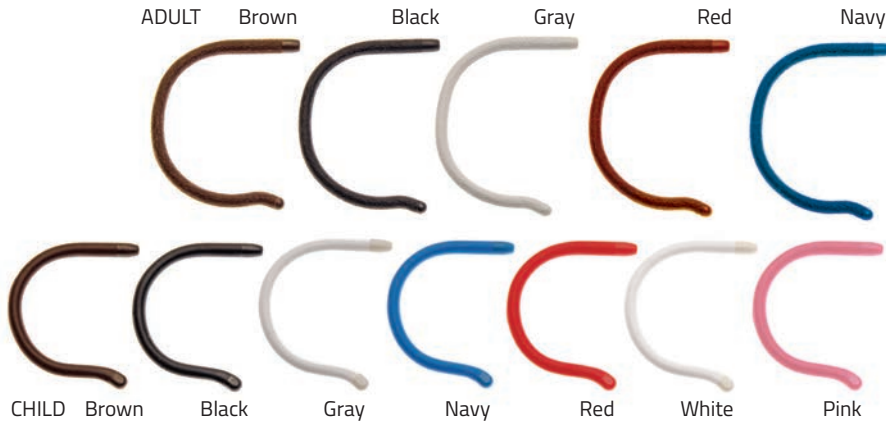

- Convert a spatula temple to a cable
- 1.4mm core diameter
- 2 pairs/package

\$12.95/pkg 10 or more \$10.95/pkg

| Color | Adult Item # | Child Item # |
|-------|--------------|--------------|
| Brown | 4814602 | 4814702 |
| Black | 4814603 | 4814703 |
| Gray | 4814605 | 4814705 |
| Navy | — | 4814706 |
| Red | 4814607 | 4814707 |
| White | — | 4814708 |
| Pink | — | 4814709 |

Temple & Cable Kits

Slim Temple Tip Kit

Our new slim style temple ends include:

- 5 pair each: Black, Brown, Tortoise, and Clear
- 1.1, 1.2, 1.4, 1.5, and 1.6mm sizes.
- 100 Pair



4810001 \$104.95

Heat Shrink Temple Tubing Kit

- Features 10 pieces each of durable shrink-to-fit tubing
- Black 1/8" and 3/16" sizes, and clear 3/32", 1/8", and 3/16" sizes



4810003 \$29.95

Adult Conversion Kit

Includes organizer and 2 pair each of 5 colors.

4814601 \$54.95

Children's Kit

Includes organizer and 2 pair each of 7 colors.

4814701 \$73.95



Slip-On Temple Comfort Cushions

Temple cushions slide over uncomfortable temple ends and help to prevent slipping. 10 pairs/package.



\$19.95/10 pairs per pkg

| Size | Dimension | Item# |
|-------------|---------------|---------|
| Extra Small | 3.3mm dia | 4800901 |
| Small | 3.5mm x 4.4mm | 4801901 |
| Medium | 3.7mm x 4.8mm | 4802901 |
| Large | 3.8mm x 5.0mm | 4803901 |

Heat Shrink Temple Tubing

- 4" length PVC tubing in three convenient diameters: 1/8", 3/16", and 3/32"
- Tubing shrinks up to 1/2 original diameter
- The 3/32" size is perfect for clip-ons



\$5.95/10 pcs per pkg

| Color | Diameter | Item # | Color | Diameter | Item # |
|-------|----------|---------|-------|----------|---------|
| Clear | 3/32" | 4821801 | — | — | — |
| Clear | 1/8" | 4831801 | Black | 1/8" | 4831803 |
| Clear | 3/16" | 4847801 | Black | 3/16" | 4847803 |

Megalock Cable Conversion Ends

Temple cushions slide over uncomfortable temple ends and help to prevent slipping.

\$24.95/package of 10

Black 4812803

Clear 4812800



Hard Acetate Temple

\$7.25/pkg 5 pairs per package 10 or more \$6.25/pkg

All lengths are 4.0mm

Slim Temple Tips

Without the wide paddle.

| CORE DIAMETER | CLEAR | BROWN | BLACK | TORTOISE |
|---------------|---------|---------|---------|----------|
| 1.3mm | 4813101 | 4813102 | 4813103 | 4813104 |
| 1.4mm | 4814201 | 4814202 | 4814203 | 4814204 |
| 1.5mm | 4815201 | 4815202 | 4815203 | 4815204 |
| 1.6mm | 4816201 | 4816202 | 4816203 | 4816204 |
| 1.9mm | 4819201 | 4819202 | 4819203 | 4819204 |

Wide Paddle Temple Tips

Traditional shape.

| CORE DIAMETER | CLEAR | BROWN | BLACK | TORTOISE |
|---------------|---------|---------|---------|----------|
| 1.5mm | 4815301 | 4815302 | 4815303 | 4815304 |
| 1.6mm | 4816301 | 4816302 | 4816303 | 4816304 |

Ultra Thin Temple Tips

For Stainless & Titanium Frames.

| CORE DIAMETER | CLEAR | BROWN | BLACK | TORTOISE |
|---------------|---------|---------|---------|----------|
| 1.1mm | 4811101 | 4811102 | 4811103 | 4811104 |
| 1.2mm | 4812101 | 4812102 | 4812103 | 4812104 |

Extra Long Temple Tips

1.3mm x 13.5mm.

| CORE DIAMETER | BROWN |
|---------------|---------|
| 1.2mm | 4813403 |





Still Cleaning Your Glasses
With the Same Old Cleaner?

Introducing
Our Revolutionary Lens Cleaner

UltraVue[®]
Gel

Go to Pages 20-21 and 24-26 for More Product Information

tools

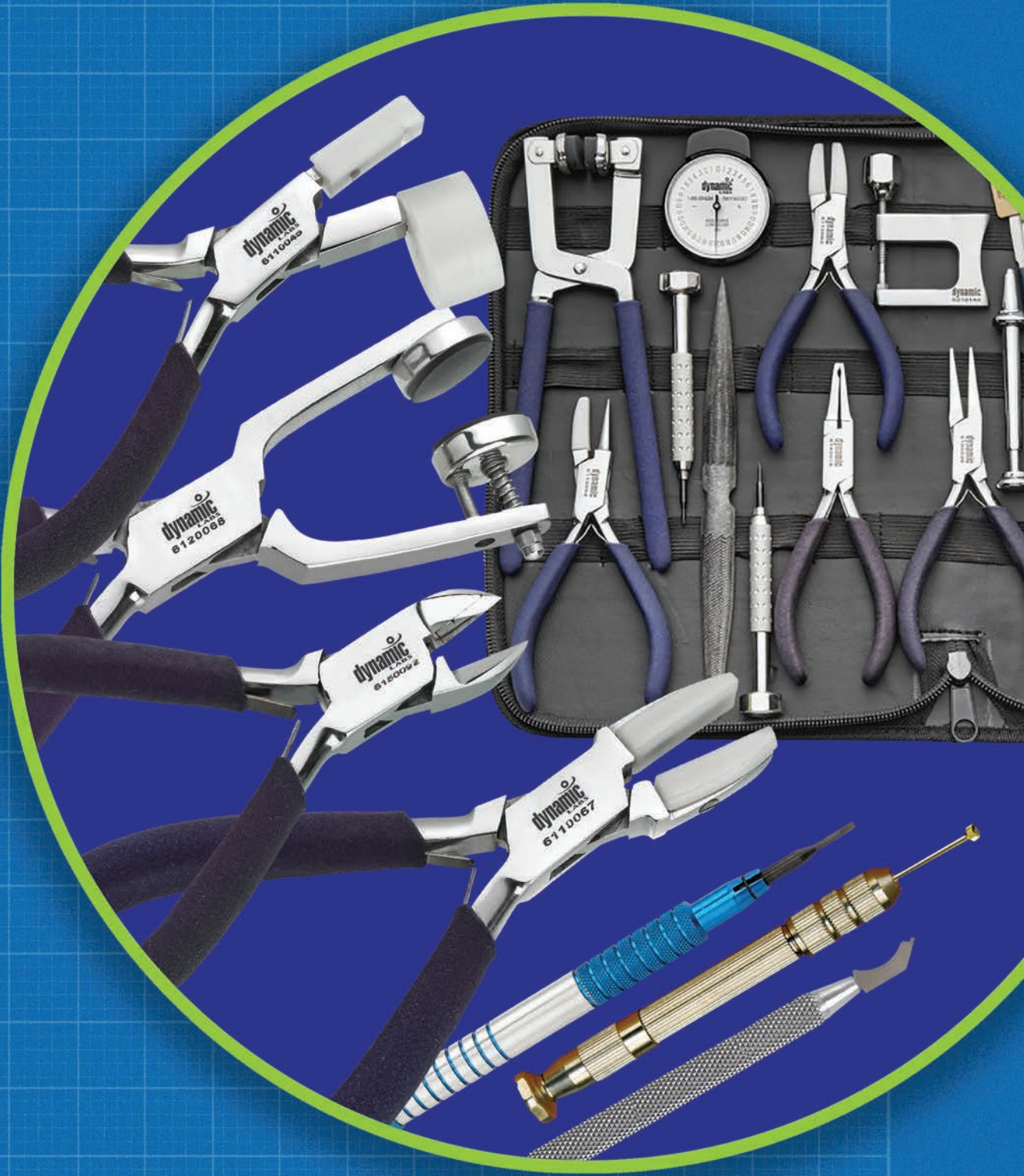

Screwdrivers

Deluxe Optician Screwdrivers

Designed for lab work, our stainless screwdrivers have a no-roll cap, a no-slip trunk, and feature a ball-bearing blade seat to make changing blade tips easy and quick.



| | | |
|-----------------------------------|-------------------|---------------------|
| Flat Blade | Phillips Blade | Flat/Phillips Blade |
| 1.5/1.5mm 6611515 | 1.5/2.0mm 6621525 | 2.2/2.2mm 6632225 |
| 1.5/2.2mm 6611522 | | |
| \$21.95/ea. 6 or more \$19.95/ea. | | |

Premium BlueLine™ Screwdrivers

Medium-weight, sturdy and comfortable handles with a large swivel cap. Available in 4 styles with interchangeable, reversible blades.



| | | |
|-----------------------------------|-------------------|---------------------|
| Flat Blade | Phillips Blade | Flat/Phillips Blade |
| 1.5/1.5mm 6711515 | 1.5/2.0mm 6721525 | 2.2/2.2mm 6732225 |
| 1.5/2.2mm 6711522 | | |
| \$14.95/ea. 6 or more \$12.95/ea. | | |

Anodized Aluminum Screwdrivers

Handles Are Made of Anodized Aircraft Grade Aluminum

- Has a no roll cap
- A snap ring for use with double-ended blades
- Features a removable pocket clip so you always know where they are



| | |
|---------------------------------|--|
| Flat Blade | |
| 1.5/1.5mm 6411515 | |
| 1.5/2.2mm 6411522 | |
| Phillips Blade | |
| 1.5/2.0mm 6422014 | |
| \$7.95/ea. 6 or more \$5.95/ea. | |

Scratchless Screwdrivers

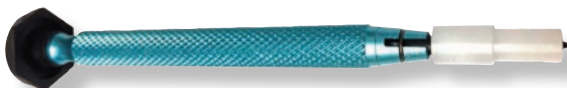

Designed for mounting screw-on type rimless lenses. The blade is recessed into a nylon sleeve that will not scratch the lenses or injure your hand should slippage occur.

| | |
|-------------------|-------------------|
| Flat Blade | Phillips Blade |
| 1.5/2.2mm 6811522 | 1.5/2.5mm 6832225 |

Replacement Blades

| | |
|---|---------|
| FLAT 1.5/2.2 Blades/Pkg | 6911522 |
| PHILLIPS 1.5/2.5mm Blades/Pkg | 6932225 |
| \$11.95/ea. 2 Pack Replacement Blades \$12.95/ea. | |

Screwdriver Replacement Blades

| | |
|--|-------------------|
| Flat Blades | Phillips Blades |
| 1.5/1.5mm 6511515 | 1.5/2.0mm 6522014 |
| 1.5/2.2mm 6511522 | 2.2/2.2mm 6532225 |
| 3 Pack \$12.95/pkg. 6 or more \$10.95/pkg. | |

Pick-Up Screwdrivers

Holds screws securely while removing or inserting by spring tension.

| | |
|-----------------------------------|----------------|
| Flat Blade | Phillips Blade |
| 2.0mm 6491020 | 2.0mm 6492020 |
| \$18.95/ea. 4 or more \$16.95/ea. | |

| | |
|--|-------------------------|
| Flat Blade | Phillips Blade |
| Blade and Clamp 6491023 | Blade and Clamp 6492024 |
| \$12.95/ea. Package of 3 Blades or 1 Blade and Clamp | |

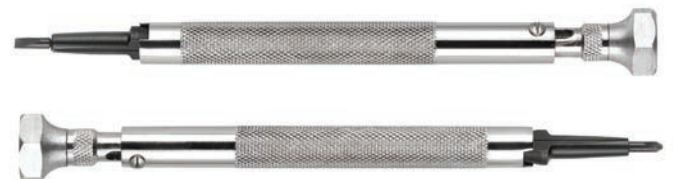

Pick-Up Screwdriver Set

Contains 1 Flat and 1 Phillips As Seen Above
6391000 \$29.95





Deluxe Optician's Screwdriver Set

Features the stainless screwdriver with no-slip handle and ball-bearing head.

Contains:

- 2 Flat-blade screwdrivers
- 1 Phillips
- 1 Phillips/flat-blade

6300010 \$79.95



Standard Screwdriver Set

Features the anodized aircraft-grade aluminum screwdriver.

Contains:

- 2 Flat-blade screwdrivers
- 1 Phillips
- 1 Phillips/flat-blade

6300004 \$25.95

BlueLine™ Optician's Screwdriver Set

Features the stainless screwdriver with no-slip handle and large swivel cap.

Contains:

- 2 Flat-blade screwdrivers
- 1 Phillips
- 1 Phillips/flat-blade

6300025 \$59.95



Nosepad Adjusting Kit

Features the stainless screwdriver with a no-slip handle and a ball-bearing head.

Contains:

- 2 Flat-blade screwdrivers
- 1 Nosepad adjusting Plier
- 1 Nosepad popper

6300211 \$89.95



NEW PRODUCT

Slim Nosepad Tweezer

Quickly remove nosepads with this simple tool!

6057737 \$12.95

6 or more \$9.95



Small Nosepad Tweezer

6057738 \$12.95

6 or more \$9.95



NEW PRODUCT

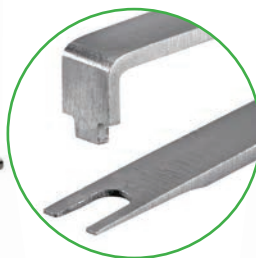

Precision 9-Piece Screwdriver/Wrench Set

An organized "all-in-one" screwdriver and wrench solution. Compact footprint with a ball bearing rotating base. Markings on handles and base for easy identification.

NEW PRODUCT



Contains:

- 3 Hex wrenches: 2.02mm, 2.32mm, 2.57mm
- 2 Star wrenches: 2.52mm, 2.82mm
- 2 Flat screwdrivers: 1.6mm, 1.8mm
- 2 Phillips screwdrivers: 1.5mm, 1.8mm

6215149 \$97.95

Self-Closing Tweezers

Holds the screw when you release your grip!

6057739 \$12.95/ea

6 or more \$9.95/ea



Screw Holding Tweezers

Handy for close, small work at the bench.

6057730 \$7.95/ea

6 or more \$6.95/ea



NEW PRODUCT

Wrenches and Extractors

Standard Wrench Set

Includes 1 each of the following wrenches:

- 2.0mm Hex
- 2.3mm Hex
- 2.5mm Hex
- 2.2mm Star
- 2.8mm Star
- 2.0mm Square



6300006 \$47.95/ea.



Ejector Wrenches

Red Head
Fits up to 2.8 Star and Hex nuts.

6495028 \$12.95

Silver Head
Fits 2.5 Hex nuts.

6495025 \$12.95

Blue Head
Fits 2.2 Star and Hex nuts.

6495022 \$12.95

Ejector Wrench Set

3 sizes to accommodate most size nuts. Press down on the end to eject the nut from the wrench.



6394400 \$29.95/ea.

Anodized Aluminum Wrenches

Our wrenches use handles made of blue anodized aircraft grade aluminum, have a no roll cap, snap ring for use with double-ended blades, and feature a removable pocket clip. Blades are also interchangeable with our stainless steel ball-bearing models.

| Hex | Star | Square |
|---------------|---------------|---------------|
| 2.0mm 6440020 | 2.2mm 6450022 | 2.0mm 6460020 |
| 2.3mm 6440023 | 2.8mm 6450028 | |
| 2.5mm 6440025 | | |

\$9.95/ea. 6 or more \$7.95/ea.

3 Pack Replacement Blades

| | | |
|---------------|---------------|---------------|
| 2.0mm 6540020 | 2.2mm 6550022 | 2.0mm 6560020 |
| 2.3mm 6540023 | 2.8mm 6550028 | |
| 2.5mm 6540025 | | |

\$12.95/pkg 6 or more \$10.95/pkg



Screw Extractor Plier

NEW PRODUCT



Easily removes broken or damaged screws.

6110022 \$34.95

6 or more \$29.95

Midget Screw Extractor

Remove stripped or stubborn screws, eliminates the need for drilling.

6215145 \$44.95/ea.

2 or more \$39.95/ea.

4 or more \$34.95/ea.

Screw Pin Replacement

6215146 \$14.95



Extractors

1.25mm 6470125

1.5mm 6470015

2.0mm 6470020

\$8.95/ea.

3 Pack Replacement Blades

1.25mm 6570125

1.5mm 6570015

2.0mm 6570020

Replacement Blades \$7.95/pkg

Screw Extractor Set

Includes 1 each of the 3 extractors listed in the table above, with accompanying blade.

6370000 \$29.95/ea.



Measuring Tools

Prescription Aligner

Verify seg heights and center of vision placements for accuracy and positioning

6621205 \$39.95

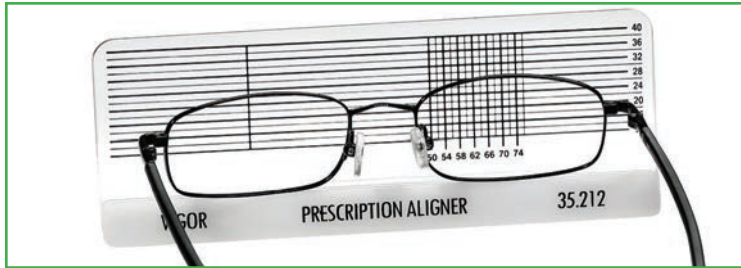

Seg Height Gauge

- Simply slips in frame
- Easy and accurate segment placement suggestion

6622005 \$11.95/pair

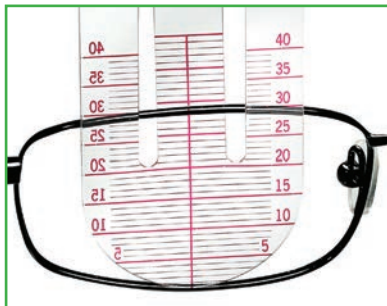

Rulers

6" Stainless Steel PD Ruler

6615001 \$3.00/ea 12+ \$2.50/ea



6" Clear PD Ruler

6615003 \$1.65/ea 6615013 12/pk \$13.65/ea



6" Black PD Ruler

6615103 \$2.25/ea



6" White PD Ruler

6615203 \$2.25/ea



Distometer

Easily measure vertex distance

6642106 \$139.95

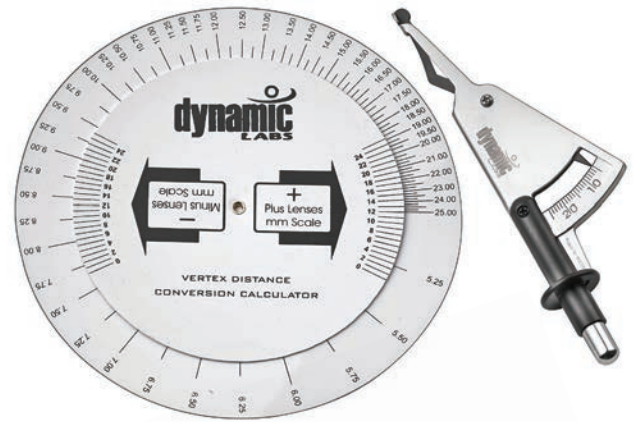

Digital Vernier Caliper-100mm

Digital read-out makes precise measurements a breeze!

6677100 \$44.45

Wide Throat Lens Thickness Caliper

Has the clearance needed for measuring around just about any lens blank or frame. Stainless Steel and Brass.

6649022 \$59.95

Caliper Tips

6649023 \$6.95

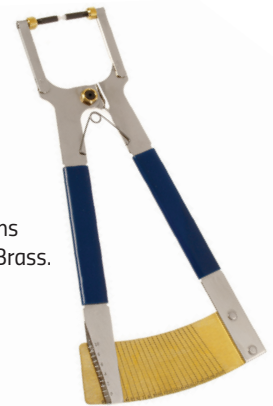

Ball Tip Measure

A great, easy to use lens clock at a great price!

6633307 \$69.95/ea.
4 or more \$59.95/ea.

Circumference Measure

Easily size lenses in seconds.

6641000 \$39.95

Replacement Tape

6641100 \$12.95



Bracing Bending Pliers



Temple End Shaping Pliers

An excellent choice, makes the mastoid curve at the end of the temple. Nylon jaws ensure a non-marring grip.

6110045 \$34.95
6 or more \$29.95 ea
Repl. Jaw - 6111045 \$7.95



Flat/Round Nylon Jaw Pliers

Immobilizes the frontpiece while making temple adjustments forward of the hinge. One nylon and one flat metal jaw prevents damage to the finish.

6110064 \$34.95
6 or more \$29.95 ea
Repl. Jaw - 6111064 \$7.95



Flat/Round Jaw Wire Bending Pliers

Use for tight curves in nosepad arms or end piece mountings. Make sharp 90° bends or graceful looping curves.

6110047 \$34.95
6 or more \$29.95 ea



Double Round Nose Pliers

Creates intricate loops akin to nosepad arms.

6110029 \$34.95
6 or more \$29.95 ea



Bracing Bending Pliers



Hinge Brace Panto Angling Pliers

Braces hinge while making adjustments to the temple angle.

6110041 \$34.95
6 or more \$29.95 ea



Wide Hinge Panto Angling Pliers

Wide throat for extra clearance on plastic frames or thick temples.

6110065 \$34.95
6 or more \$29.95 ea



Nylon Endpiece Bracing Pliers

Immobilizes the frontpiece while making temple adjustments forward of the hinge. One nylon and one flat metal jaw to prevent damage to the finish.

6110037 \$34.95
6 or more \$29.95 ea

Repl. Jaw - 6111037 \$7.95



Nylon Endpiece Ergonomic Pliers

Same classic endpiece bracing pliers with a more ergonomic handle.

6110137 \$36.95
6 or more \$31.95 ea

Repl. Jaw - 6111137 \$7.95



Bracing Bending Pliers



Slim Double Nylon Bracing Pliers

Use these non-marring slender tipped pliers for bracing, bending and holding where clearance is tight.

6110062 \$34.95
6 or more \$29.95 ea

Repl. Jaw - 6111062 \$7.95



Slim Double Nylon Ergonomic Pliers

Wide throat for extra clearance on plastic frames or thick temples.

6110162 \$36.95
6 or more \$31.95 ea

Repl. Jaw - 6111162 \$7.95



Double Nylon Bracing Pliers

Use for bracing, bending and holding with the added protection of nylon for today's delicate finishes.

6110067 \$34.95
6 or more \$29.95 ea

Repl. Jaw - 6111067 \$7.95



Grooved Double Nylon Pliers

Use these to bend bows, repair misshaped eyewires, or make adjustments. The groove provides added control.

6110071 \$34.95
6 or more \$29.95 ea

Repl. Jaw - 6111071 \$7.95



Bracing Bending Pliers



Curve Forming Pliers

Aligns eyewires with base curves or to help reshape them, also great for temples.

6110069 \$34.95
6 or more \$29.95 ea
Repl. Jaw - 6111069 \$7.95



Curve Forming Ergonomic Pliers

Same classic curve forming pliers with a more ergonomic handle.

6110169 \$36.95
6 or more \$31.95 ea
Repl. Jaw - 6111069 \$7.95

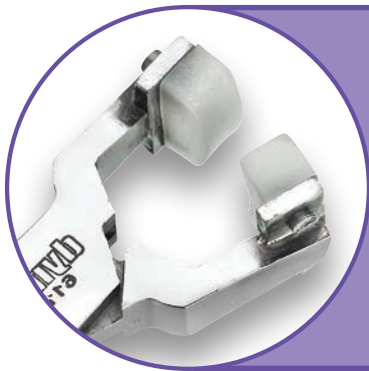

Mini Curve Forming Pliers

Use on bridges and temples.

6110072 \$34.95
6 or more \$29.95 ea
Repl. Jaw - 6111072 \$7.95



Plastic Frame Bracing Pliers

Fiber jaw for a non-marring sure grip. Use for bracing, holding and setting rivet shields.

6110044 \$34.95
6 or more \$29.95 ea
Repl. Jaw - 6111044 \$7.95



Bracing Bending Pliers continues next page

Bracing Bending Pliers

**NEW
PRODUCT**



Bridge Adjusting Pliers

Easily reduces the bridge of a metal frame for the perfect fit. Great for small PD's.

6110021 \$34.95
6 or more \$29.95 ea



Rimless Pliers



Classic Numont Pliers

Braces and adjusts rimless and semi-rimless temples and eyewires. A must have for every Optician or Lab Technician.

6130008 \$34.95
6 or more \$29.95 ea



Ergonomic Numont Pliers

Same as our classic Numont pliers with a more ergonomic handle.

6130108 \$36.95
6 or more \$31.95 ea



Rimless Screw Holding Pliers

Use on screw-fitted three piece mountings. Put the screw through the slot on one side to adequately hold while adjusting.

6130007 \$34.95
6 or more \$29.95 ea

Repl. Jaw - 6131007 \$7.95



Rimless Pliers



Rimless Compression Mount Pliers

Use on three-piece compression style mounting systems to install the bushings. Can also be used for a bracing plier on these frame types.

6130013 \$34.95
6 or more \$29.95 ea
Repl. Jaw - 6131013 \$7.95



Ergonomic Rimless Compression Mount Pliers

Same compression system as our 6130013 with a more ergonomic handle.

6130113 \$36.95
6 or more \$31.95 ea
Repl. Jaw - 6131113 \$7.95



Rimless Bushing Cutting Pliers

Use on three-piece rimless bushings exclusively. The cutting end is highly polished to eliminate the risk of damage to lenses. Use on other materials is not recommended. 7mm wide.

6130011 \$34.95
6 or more \$29.95 ea



Thin Bushing Cutting Pliers

Same cutting system as our 6130011 with a thinner head to get in tight places. Use on other materials is not recommended. 4mm wide.

6130313 \$36.95
6 or more \$31.95 ea



Rimless Pliers continues next page

Rimless Pliers



Rimless Bushing Pulling Pliers

Use on three-piece rimless bushings exclusively, cutting end is highly polished and eliminates the risk of damage to lenses. Use of this on other materials is not recommended.

6130012 \$34.95
6 or more \$29.95 ea

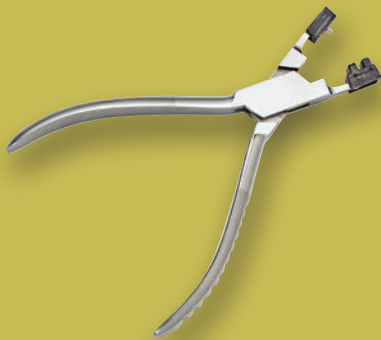

Rimless Bushing Pushing Pliers

Need to push a double pin compression bushing out? This is the right tool!

6130014 \$34.95
6 or more \$29.95 ea



Parallel Pliers



Parallel Jaw Flat Nose Pliers

The same as a standard flat nose plier with the added advantage of having parallel jaws for added stability.

6160006 \$44.95
6 or more \$39.95 ea



Parallel Jaw Round Nose Pliers

Double round nose jaws create intricate loops akin to nose pad arms. Parallel jaws give added stability.

6160005 \$44.95
6 or more \$39.95 ea



Parallel Pliers



Parallel Jaw Flat / Round Pliers

Immobilizes the frontpiece while making temple adjustments forward of the hinge. One nylon and one flat metal jaw prevents damage to the finish.

6160004 \$44.95
6 or more \$39.95 ea
Repl. Jaw - 6161004 \$7.95



Parallel Jaw Double Nylon Pliers

Use for bracing, bending and holding with the added protection of nylon for today's delicate finishes.

6160003 \$44.95
6 or more \$39.95 ea
Repl. Jaw - 6161003 \$7.95 (set of 2)



Parallel Jaw End Cutting Pliers

Makes cutting stainless steel screws much easier.

6160002 \$44.95
6 or more \$39.95 ea



Parallel Jaw Side Cutter

Makes cutting stainless steel screws and temple tips much easier.

6160001 \$44.95
6 or more \$39.95 ea



Nosepad Pliers



Classic B&L Nosepad Adjusting Pliers

Adjusts just about any nosepad, as well as installing crimp on nosepads seen on many antique and retro frame styles.

6140046 \$34.95
6 or more \$29.95 ea



Push In Nosepad Removal Pliers

Never ruin a frame or misalign a nosepad arm! Place the forked jaw between nosepad and box and use the other jaw to pop nosepad right out!

6140048 \$34.95
6 or more \$29.95 ea



Fine Nosepad Arm Adjusting Pliers

Virtually no clearance problems for this tool!

6140014 \$34.95
6 or more \$29.95 ea



European Style Nosepad Adjusting Pliers

Grooved jaw fits around pad box for a sure grip.

6140016 \$34.95
6 or more \$29.95 ea



Specialty Pliers



Eyewire Sizing Pliers

Use for verifying circumference sizing between edging cycles.

6170055 \$34.95
6 or more \$29.95 ea



Vitale Deblocking Pliers

Reduces flex on lens during deblocking. Exclusive ergonomic design helps reduce carpal tunnel syndrome.

6170060 \$34.95
6 or more \$29.95 ea



Sizing Screw Insertion Pliers

Easily get screw started in any frame.

6110020 \$34.95
6 or more \$29.95 ea



Screw Extractor Plier

This may be your new favorite tool. Easily removes broken or damaged screws.

6110022 \$34.95
6 or more \$29.95 ea



Specialty Pliers continues next page

Specialty Pliers



Vital Nidek Deblocking Pliers

Specially designed to fit Nidek blocks. Reduces flex on lens during deblocking. Exclusive ergonomic design helps reduce carpal tunnel syndrome.

6170061 \$34.95
6 or more \$29.95 ea



Screw Peening/Flaring Pliers

Use for flaring screw ends or rivets to prevent loosening.

6170054 \$34.95
6 or more \$29.95 ea



Chain/Nose/Snipe Nose Pliers



Short Chain Nose Pliers

High quality, with fine points and superior box joint construction to minimize deflection.

6150024 \$34.95
6 or more \$29.95 ea



Needle Nose Pliers

Long flat jaws for manipulation in smaller spaces.

6150026 \$34.95
6 or more \$29.95 ea



Chain/Nose/Snipe Nose Pliers



Long Chain Needle Nose Pliers

Extra long flat jaws for manipulation in tight areas.

6150028 \$34.95
6 or more \$29.95 ea



Bent Chain Nose Pliers

Useful for bending nosepad arms.

6150025 \$34.95
6 or more \$29.95 ea



Cutting Pliers



Standard Side Cutter

Specially designed tool allows jaws to cut screws very close and still retain a super sharp edge.

6150091 \$34.95
6 or more \$29.95 ea



Ergonomic Standard Side Cutter

Same classic side-cutter with a more ergonomic handle.

6150191 \$36.95
6 or more \$31.95 ea



Cutting Pliers continues next page

Cutting Pliers



Short Oblique Cutter

Oblique end cutter for use on nickel and softer metals.

6150294 \$34.95
6 or more \$29.95 ea



Carbide Short Oblique Cutter

Carbide tip cuts stainless steel screws. Short, oblique angle is ideal for tight places

6150394 \$44.95
6 or more \$39.95 ea



Diagonal Heavy Duty Cutter

Use on stainless screws. Semi-flush cut.

6150092 \$39.95
6 or more \$34.95 ea



Ergonomic Heavy Duty Cutter

Heavy duty side-cutter with a more ergonomic handle.

6150192 \$41.95
6 or more \$36.95 ea



Cutting Pliers



Standard Oblique Cutter

Oblique end cutter for use on nickel and softer metals.

6150093 \$34.95
6 or more \$29.95 ea



Oblique Flush End Cutting Pliers

Flush cutting nipper for nickel screws.

6150094 \$34.95
6 or more \$29.95 ea



Ergonomic End Cutting Pliers

This cutter will allow you to cut just about any material, screw or temple for many years when used properly. Same classic end-cutting jaws with a more ergonomic handle.

6150194 \$36.95
6 or more \$31.95 ea



Temple Snipper

Use on titanium or stainless temples.

6150095 \$34.95
6 or more \$29.95 ea



Cutting Pliers continues next page

Cutting Pliers



Lever-Action Carbide End Cutter

Lever-action makes cutting stainless steel screws much easier.

6150096 \$64.95
6 or more \$54.95 ea



Lever-Action Carbide Side Cutter

Lever-action makes cutting stainless steel screws much easier.

6150098 \$64.95
6 or more \$54.95 ea



Axis Pliers



Ergonomic Small Eyesize Axis Adjusting Pliers

Same as our 6120009 pliers with a more ergonomic handle.

6120109 \$36.95
6 or more \$31.95 ea

Repl. Jaw - 6121109 \$7.95



Tool Holders

Our selection of professional tool holders keeps your work bench organized while not taking up a lot of space.

See our entire selection on page 111.





Deluxe Axis Adjusting Pliers

Extra long handles provide increased leverage with a wide throat for extra clearance. Special jaw design will not twist.

6120068 \$34.95
 6 or more \$29.95 ea
 Repl. Jaw - 6120069 \$7.95



Ergonomic Deluxe Axis Adjusting Pliers

Same special jaw design as our standard axis adjusting pliers with a more ergonomic handle.

6120168 \$36.95
 6 or more \$31.95 ea
 Repl. Jaw - 6121067 \$7.95



Economy Axis Adjusting Pliers

A great quality axis plier at a great price.

6120067 \$24.95
 6 or more \$19.95 ea
 Repl. Jaw - 6121067 \$7.95



Small Eyesize Axis Adjusting Pliers

Small footprint jaws with lots of leverage! It's about time!

6120009 \$34.95
 6 or more \$29.95 ea
 Repl. Jaw - 6121009 \$7.95



Parallel Jaw Plier Kit

6160007 \$195.95
2 or more \$175.95/ea.

6160001
Parallel Jaw
Side Cutter



6160004
Parallel Jaw Flat /
Round Pliers



6160002
Parallel Jaw
End Cutting Pliers



6160003
Parallel Jaw Double
Nylon Pliers



6160005
Parallel Jaw Round
Nose Pliers



6160006
Parallel Jaw
Flat Nose Pliers

Standard Optician's Tool Kit

6300017 \$225.95
2 or more \$199.95/ea.

6110064
Flat/Round
Pliers

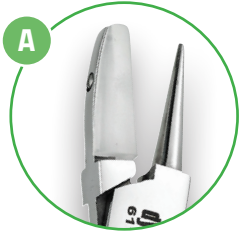

6140016
Euro Style Nosepad
Adjusting Pliers

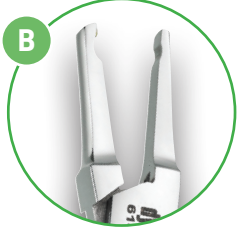

5999941
Zylonite 8" Coarse
and Extra-coarse File



6120009
Small Eyesize
Axis Adjusting Pliers



6150394
Carbide Short
Oblique Cutter

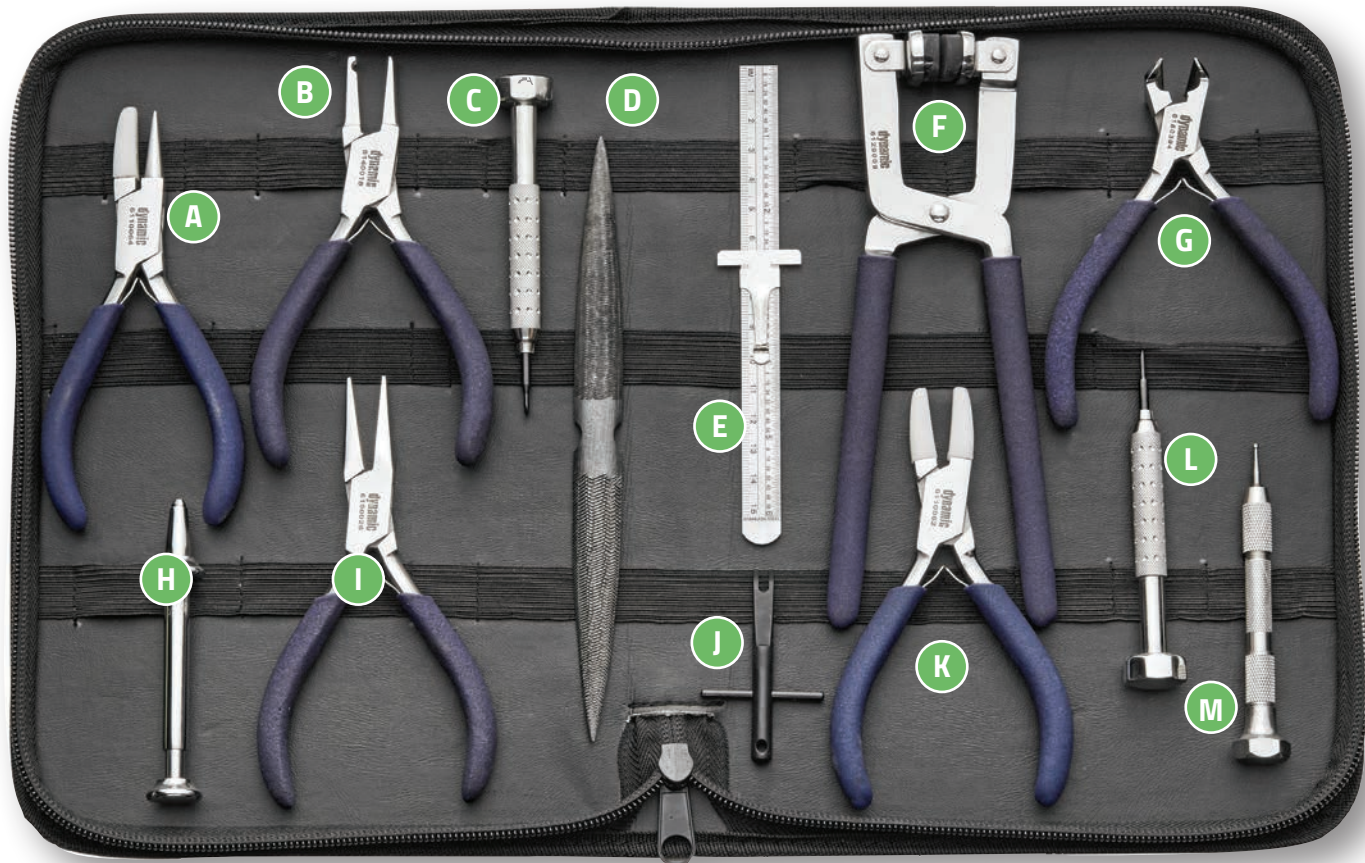

- C** 6621525 1.5/2.0mm Phillips Blade Screwdriver
- E** 6615001 6" Stainless PD Rulers
- H** 6480000 Universal Nut Driver

- J** 6210048 Nosepad Popper
- L** 6611522 1.5/2.2mm Flat Blade Screwdriver
- M** 5999901 Deburring Tool



6150026
Long Chain
Nose Pliers

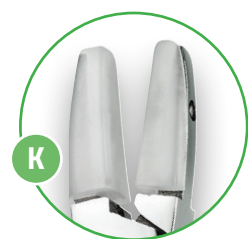

6110062
Slim Double Nylon
Bracing Pliers

Deluxe Optician's Tool Kit

6300015 \$299.95
2 or more \$279.95/ea.

6215145
Midget
Screw Extractor



6649022
Wide Throat Lens
Thickness Calipers

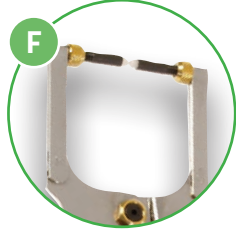

A **6120009** Small Eyesize Axis
Adjusting Pliers

B **6633307** Ball Tip Measure

C **6110062** Slim Double Nylon
Bracing Pliers

E **6480000** Universal Nut Driver

G **5999901** Deburring Tool

J **6621525** 1.5/2.0mm
Phillips Screwdriver

K **5999941** Zylonite File

L **6611522** 1.5/2.2mm Flat
Blade Screwdriver

O **6615001** 6" Stainless
PD Rulers

Q **6210048** Nosepad Popper

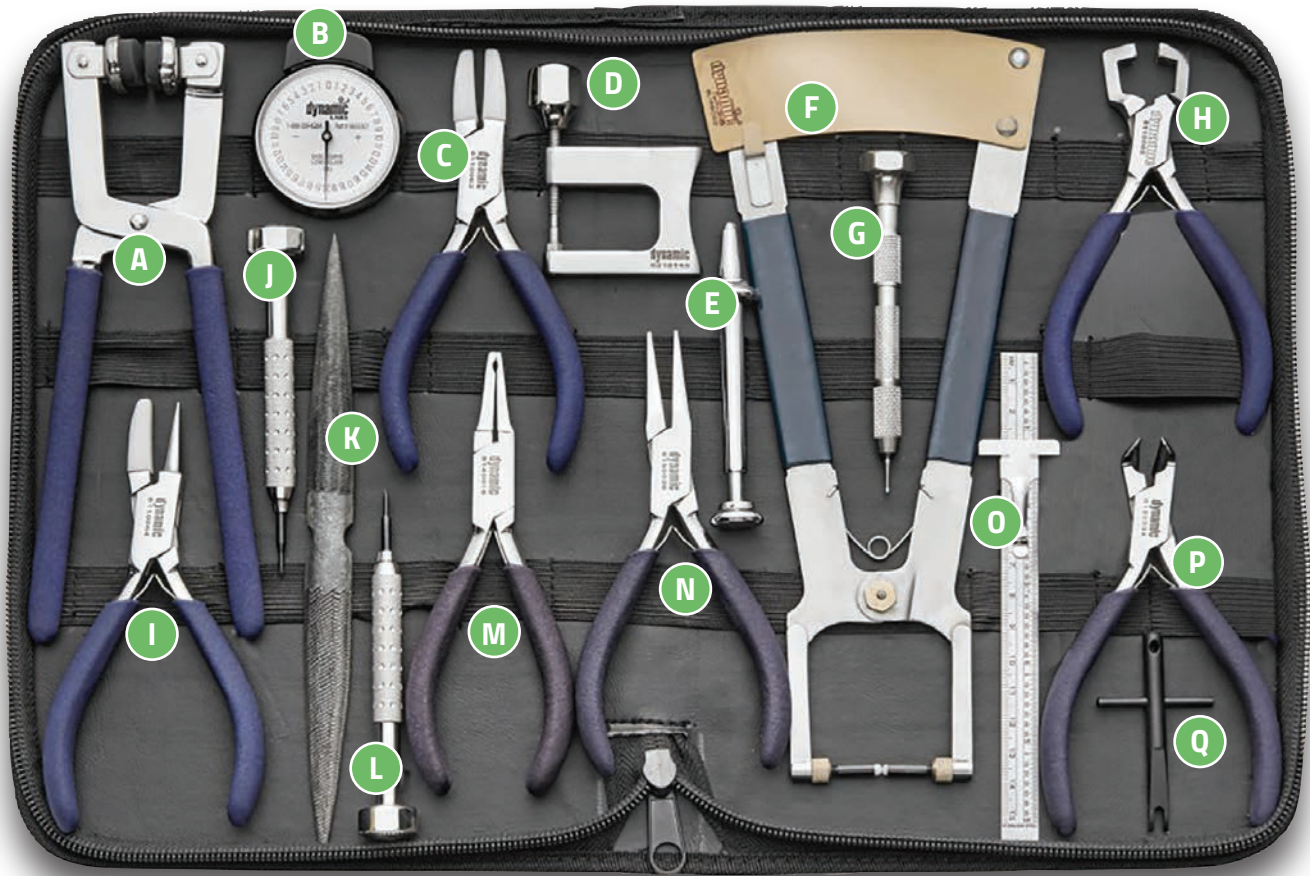

6110065
Wide Hinge Panto
Angling Pliers



6110064
Flat/Round
Pliers



6140016
Euro Style Nosepad
Adjusting Pliers



6150026
Long Chain
Nose Pliers



6150394
Carbide Short
Oblique Cutter



Rimless Tool Kit

630005 \$195.95
2 or more \$189.95/ea.

5999902
Chamfering
Tool

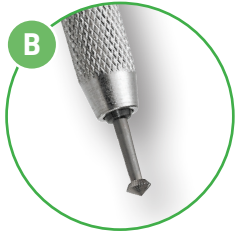

6215126
Scribe/
Alignment Tool



5999901
Deburrer

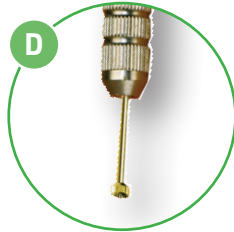

E 4508027 Silhouette Style
1.4mm Bushings

4508028 Silhouette Style
1.5mm Bushings

4508029 Silhouette Style
1.6mm Bushings

4508025 Marchon Airlock
Style Bushings

4508038 Kawasaki
Style Bushings

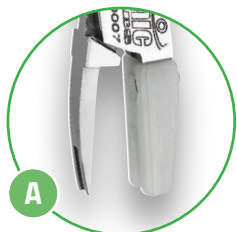

6130007
Rimless Screw
Bracing Pliers



6130013
Rimless
Compression Pliers



6130012
Rimless Frame
Pulling Pliers



6130011
Rimless Bushing
Trim Pliers



6150094
Oblique
End Cutter

Ergo Pliers Tool Kit

6300003 \$299.95
2 or more \$269.95/ea.

6110169
Curve Forming
Pliers

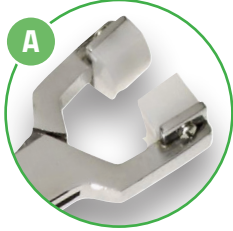

6130113
Rimless
Compression Pliers

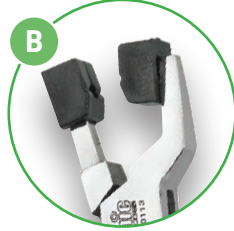

6110137
Nylon Endpiece
Bracing Pliers

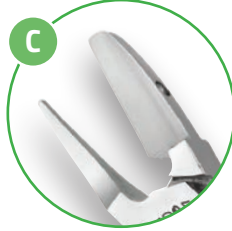

6150191
Standard Side
Cutter Pliers



6150192
Heavy Duty Side
Cutter Pliers



6110162
Slim Double Nylon
Bracing Pliers



6150194
End Cutting Pliers



6130108
Numont Pliers



6120168
Deluxe Axis
Adjusting Pliers



6120109
Small Eyesize Axis
Adjusting Pliers



Leatherette Tool Case

Great portability for your tools.

6109902 \$39.95



Magnetic Screw Pad

- For use on the workbench area to help prevent screws and small parts from bouncing
- Size: 12" x 15"

6215127 \$11.95/ea.
6 or more \$9.95/ea.
12 or more \$7.95/ea.



Tool Rack

Tool and supplies holder that holds all your repair and assembly frame parts readily available to you on your desktop.

6109905 \$50.95



Aluminum Tool Holder

Professional looking tool holder for your public work space.

6109904 \$24.95



Bench Magnetic Tool Holder

Magnetically Holds Tools for Easy Retrieval

9" Holder

6215090 \$30.95

12" Holder

6215012 \$32.95

18" Holder

6215018 \$39.95

24" Holder

6215024 \$42.95



9" Tool Rack Shown

Files

- A** Zyl File 7" Coarse and Xtra Coarse
5999941 \$24.95
- B** Screwhead File 3" Cut 4
5999942 \$44.95
- C** Finishing File 6" Cut 2
5999943 \$29.95
- D** Narrow Pillar File 4" Cut 2
5999944 \$29.95
- E** Extra Narrow Pillar File 6" Cut
5999945 \$29.95
- F** Lens File 4.5" Superthin
5999948 \$24.95
- G** Knife File 6" Cut 2
5999947 \$43.50
- H** Rat Tail File 4" Cut 2
5999946 \$24.95

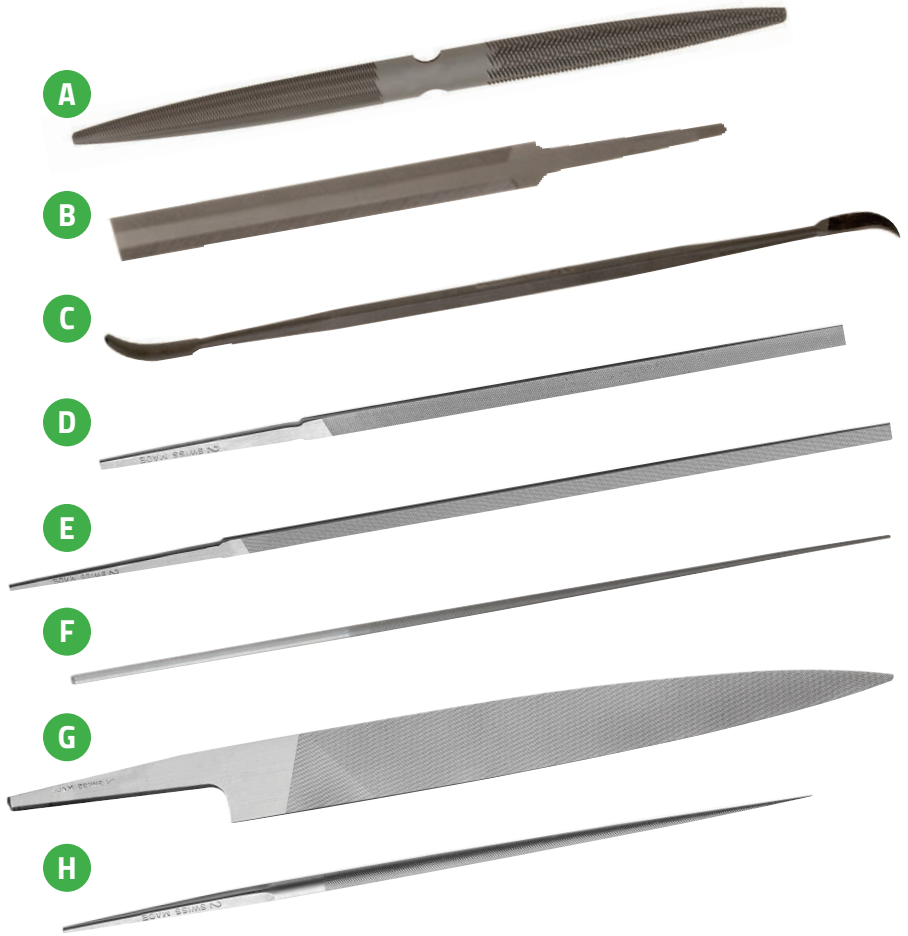

Complete File Master Set

Set Includes:

- Files-VUL-Crylic 8 Inch
- Files-Screwhead w/Tang 3 Inch #4
- Files-Round 4 Cut 2
- Files-Pillar-Narrow 4 Cut 2
- Filing Guard
- Riffler-Diesinker #965 6 Cut 2

5999950 \$199.95

5-Sided Cutting Broach With Handle

Handle Size 52 1.6mm

5999949 \$19.95



Utility Knife Handle

Excellent quality knife for all your cutting needs. Comes with single standard blade. Curved blade for use on surface tape is available.

6217101 \$11.95

Straight Blades

Standard straight pointed blades. Pack of 15.

6217102 \$19.95

Curved Blades

These blades have a reverse curve and are great for trimming surface tape or in areas where extra control is needed. Pack of 15.

6217103 \$19.95



Staking Unit With Accessories

Multi-Purpose Tool Designed to Aid the User With Repair Functions Where Extra Precision Is Needed

6215130 \$250.95



Replacement Pins

For Single and Double Pin Punches

6215135 \$16.95



Base Wing Screw
Not Shown

6215141 \$5.95

Punches

Pointed Punch

Useful for spreading screw ends to prevent loosening, or center punching prior to drilling.

6215131 \$9.95



Blunt Punch

Useful for knocking out loose or broken screws.

6215132 \$9.95



Single Pin Punch

Useful for pressing out rivets, or piercing plastic frames.

6215133 \$9.95



Double Pin Punch

Useful for pressing out double rivets, with industry standard 2.5mm spacing, or for creating holes for them.

6215134 \$19.95



Anvils

Steel Anvil

For use as a backing while peening rivets.

6215136 \$18.95



Nylon Anvil (Not shown)

6215148 \$14.95

Hinge Anvil Choke

Used to block off hole in hinge anvil, while raising the surface.

6215137 \$12.95



Small Hole Anvil

Used during rivet extraction.

6215138 \$9.95



Hinge Anvil

Used to support the hinge during stripped screw removal.

6215139 \$9.95



Custom Die Stamps

For stamping lenses. Please specify for either pliers or staking unit. 6-8 week delivery.



Custom Die Stamp With Plier
6216096 \$180.95

Custom Die Stamp For Plier
6216098 \$98.95

Custom 4 Letter Die Stamp
For Use In Staking Unit
6216097 \$110.95

Custom 3 Letter Die Stamp
For Use In Staking Unit
6216099 \$98.95

Spring Loaded Punch

Use to center punch in metal or topeen screws. Supplied with cup point.



6215123 \$34.95

Pointed Bit for Punch

6215124 \$5.95

Cup Bit for Punch

6215125 \$5.95

Drills and Taps

Hand Drill

Handy for close drilling of small work at the bench.

6277099 \$15.95



Swivel Head Drill/Tap Holder

With 2 reversible chucks to hold 4 sizes of drills, taps, screwdriver blades, from the smallest up to 1/8" or 3.2 mm. 4" long x 5/16" dia. with a 3/4" swivel head.

6279001 \$6.95



High Speed Twist Drills

- Made of the highest quality steel, carefully tempered and accurately ground to size
- All drills have straight shanks and are perfectly finished to assure quick, smooth and clean drilling
- 10 drill bits per pack



| Size | mm | Item # | Price/Pack |
|------|-------|---------|------------|
| 44 | 2.200 | 6278144 | \$12.95 |
| 47 | 2.000 | 6278147 | \$12.95 |
| 52 | 1.613 | 6278152 | \$12.95 |
| 53 | 1.500 | 6278153 | \$12.95 |
| 54 | 1.400 | 6278154 | \$12.95 |
| 55 | 1.321 | 6278155 | \$12.95 |
| 56 | 1.181 | 6278156 | \$12.95 |
| 58 | 1.067 | 6278158 | \$12.95 |
| 60 | 1.016 | 6278160 | \$12.95 |
| 61 | 0.990 | 6278161 | \$12.95 |
| 64 | 0.914 | 6278164 | \$12.95 |

High Speed Drill Bit Assortment

- 2 drill bits each of 56 and 64
- 1 each of 52, 54, 55, 58, 60 and 61 listed above

6278100 \$12.95

Tap & Drill Bit Assortment

- 10 drill bits each of the following: 5, 56, 58 and 61
- 3 taps each of the following: 1.2, 1.3, 1.4, 1.6, 1.27 and 1.38

6279009 \$179.95



Taps

3 per package.



Foreign

| Drill | Screw Dia. | Item # | Price |
|-------|------------|---------|---------|
| 61 | 1.2mm | 6279012 | \$27.95 |
| 58 | 1.3mm | 6279013 | \$27.95 |
| 56 | 1.4mm | 6279014 | \$27.95 |
| 55 | 1.6mm | 6279016 | \$27.95 |

Domestic

| Drill | Screw Dia. | Item # | Price |
|-------|------------|---------|---------|
| 56 | 1.20mm | 6279012 | \$27.95 |



Soldering Supplies and Equipment

Solder Wire

Special Solder Wire for Titanium Flux



- To be used with titanium flux
- .031" diameter
- Melts at 1240°F
- 1 oz. coil

8215303 \$74.95

Silver Solder Wire with Cadmium



- Melts at 1325°F.
- 1 oz. coil

8215301 \$79.95

Titanium Brazing Flux



Allows titanium to be brazed as if it were nickel or steel!

8245303 \$48.95

Use with Special Solder Wire or Titanium use 8215303 for best results.

Dynamic Stainless Steel Brazing Flux



- An excellent flux for preparing stainless steel for solder
- Works with High Silver content solders only (8215301)

8244601 \$9.95

Butane Lab Torch



- Adjustable flame when you need it
- This torch uses commercially available butane and ships empty

8211000 \$69.95

Soldering Station

- Multi-position clamps allow for almost any configuration
- Heat resistant base protects table during soldering



8211002 \$39.95

Silver Solder Rods With Flux

Convenient Method of Joining Metals With Strong Bond

- These solder rods with flux core do not require additional flux or cleaning agent for immediate use
- Melts at 1275°F
- 12 rods/package



8224112 \$119.95

Third Hand Solder Stand

Weighted base and clips hold frames just where you want them.



8210003 \$29.95

Heat Shield

- Protects components under direct 5000°F flame
- Prevents oxidation and is odorless and non-toxic
- Washes off with water
- 1 lb. tub



8216448 \$19.95

Solder Paste With Flux

- Dispensing applicator gives you the right amount quickly, efficiently, and economically
- Will adhere wherever applied with bright, clean results and leave little to no carbon residue
- Easy to clean up with no waste



8244205 Yellow 14K Gold \$89.95

8245105 Silver-Easy \$39.95

Universal Nut Driver

Grips and removes virtually any nut or fastener! Push in the plunger at the back to spread the jaws, place over the nut and release for a secure hold on most nut styles including even smooth decorative nuts.



6480000 \$16.95

Screw Holding Tool



- Stops drooping screws
- Pick-up, insert and remove tiny screws
- Save times
- Can also be used for nuts



6490000 \$19.95



Scribe Alignment Tool

Great for reopening rimless bushings after cutting! Etch marks into metal or plastic, or simply line up a hinge.

6215126 \$16.95

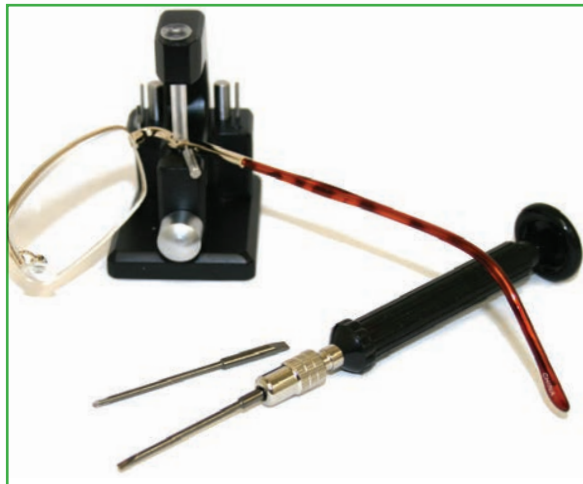

Spring Hinge Tool Kit

Now you can replace spring hinge screws quickly and easily! Unit includes vise, spacers and specially designed screwdriver.

6216100 \$99.95

Replacement pin 1.1mm

6216111 \$7.95

Replacement pin 1.4mm

6216114 \$7.95

Deburring Tool

Grinds burrs without scratching lenses.

5999901 \$19.95

Replacement Tip

6277018 \$6.95



Swarf Removal Tool

For removing residue from the edges of polycarbonate lenses.

5999960 \$19.95



Hard Bristle Cleaning Brush

Use on machinery, small parts or for general cleaning.

6215009 \$9.95



Bench Block

Firmly supports frames with a replaceable non-marring rubber for a variety of procedures.

6215210 \$9.95

Replacement Pad

6215211 \$4.95



Brass & Nylon Mallet

Non-marring nylon or soft brass for a gentler solution to jobs requiring force.

6215120 \$9.95

Brass Face Replacement

6215121 \$4.95

Nylon Face Replacement

6215122 \$4.95



Suction Mounted Swivel Vise

Suction diaphragm holds this vise securely to any smooth surface! Features non-marring rubber padded jaws and full 360 degrees of rotation.

6214750 \$79.95



Silver LED Lamp with Double-Reach Clamp

Comes with both Clamp and Base Stand

- Dimensions: 20"L x 6"W x 22"H
- Light Source: LED
- Lumens: 600 ▪ Watts: 10W
- Beam Angle: 60°
- Adjustable Color Temp:
Soft White, Bright White, Daylight
- Switch: Touch
- Dimmer: Full range
- Shade: Plastic Construction

3940365 \$99.95



LED Inspection Lamp with 3-Diopter Magnifier Lens

The Unique Combination of Lamp and Magnifier That Provides Distortion-Free Viewing With a Powerful 7-watt MR-16 bulb!

- Three interchangeable lenses
- Three magnifications, 2.5x, 5x, and 16x
- Quick and easy lens changing
- Two LED lights
- Detachable light source
- Comfortable rubber handle
- On/Off switch
- Batteries not included

3940364 \$249.95



Interchangeable Lens LED Magnifier

- Three interchangeable lenses
- Three magnifications, 2.5x, 5x, and 16x
- Quick and easy lens changing
- Two LED lights
- Detachable light source
- Comfortable rubber handle
- On/Off switch
- Batteries not included

3940363 \$19.95





REPEL TODAY!



TOP COATING FOR ALL AR LENSES

Products Available on Page 176

machines



Deluxe Digital Self-Calibrating Pupilometer

Automatically Recalibrates!

- Measures vertex distance
- Image brightness adjusting ability
- Adjustable shut off time and brightness control
- LED light – longer battery life
- Viewing window eyesight compensator



6648770 **\$399.95**

2 or More **\$369.95**

Replacement Bulb

6648774 **\$29.95**

Marking Inks

Quality Higgins waterproof ink recommended for use in lens markers and lensometers.

1 Quart Black

7314016 **\$84.95/ea.**



1 Ounce/RED

7324001 **\$9.95/ea.**

1 Ounce/BLACK

7314001 **\$9.95/ea.**



Lensometer Replacement Parts

| Lens Support | Lens Chuck | Bulb Assembly | Marking Pin & Bracket | Ink Pads (3) | Ink Assembly |
|---|---|---|--|---|---|
| 5875552 \$40.35 | 5875553 \$56.70 | 5875554 \$65.20 | 5875555 \$42.70 | 5875556 \$20.35 | 5875557 \$43.20 |
|  |  |  |  |  |  |
| Lens Stand Rubber | Marking Shaft | Presser Shaft Only | Self Ink Pins (3) | Switch | Presser Set |
| 5875516 \$3.05 | 5875517 \$23.45 | 5875527 \$8.25 | 5875561 \$149.95 | 5875558 \$20.45 | 5875559 \$58.45 |
|  |  |  |  |  |  |

Premium Lensometer

Finely Crafted, Handmade to the Highest Standards

- The Lens Pro™ Lensometer uses superior quality optics
- Includes a prism compensator in its user-friendly design
- Large ergonomic knobs are clearly marked for ease of use
- LED light – longer battery life

5875550 **\$1,233.70**

5875560 **\$1,423.70** With Self Inking Pins



Precision Scale



Relocated On-Off Switch



Prism Compensator

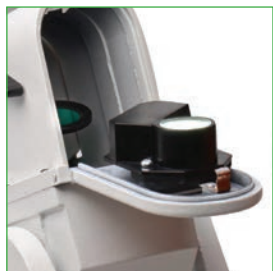

LED 25W Bulb

| | |
|---------------------|---|
| Target: | American Cross-line |
| Vertex Power: | Range: 0D to $\pm 20D$ |
| Step: | 0.125D up to $\pm 5D$; 0.25 at $\pm 5D$ to $\pm 20D$ |
| Astigmatism Axis: | 0 to 180°, minimum scale value 1° |
| Prism Diopter: | 1 diopter intervals in the range of 0D to 20D |
| Prism Base Angle: | 0 to 180°, minimum scale value 5° |
| Eye-piece Focus: | $\pm 5D$ |
| For Lens Sizes: | 30mm to 90mm in diameter |
| Overall Dimensions: | 18" x 6.75" x 9.5" |
| Weight: | 16 pounds |
| Lighting Lamp: | LED 110V 25W equivalent |

Polishing Machines

Made in the USA

Our machines come fully assembled with a powerful 1/2 HP motor, squirrel cage suction fan, fiberglass air filter, and is powder coated for a long-lasting durable finish. 1 year warranty on parts and labor.

Replacement Filter
5751022 \$42.95



Single Spindle Polishing Machine

- 15-3/8" wide x 17" deep x 10-1/2" high

5751001 \$506.95



Double Spindle Polishing Machine

- 22-1/2" wide x 19" deep x 12" high

5751002 \$599.95

Auto-Polisher

- Ideal for touch up
- Three different cycles to accommodate all materials
- Auto shut-off
- Efficient design
- 110V, 60Hz.
- One year limited warranty on parts and labor



5751003 \$489.95/ea.

2 or More \$445.95/ea.

Replacement Buff
6740325 \$29.95/ea.

Replacement Belt
5750013 \$29.95/ea.

Auto Lens Groover

- Specially designed diamond cutting wheel for smooth grooving
- Adjustable setting for groove depth
- Adjustable lens guide
- B measurement is 12mm on chuck
- One year limited warranty on parts and labor

Replacement Parts

Full Eye Chuck
5875518 \$23.95/ea.
Half Eye Chuck
5875528 \$23.95/ea.
Upper Belt
5875521 \$23.95/ea.
Lower Belt
5875522 \$23.95/ea.

Groover Blades

(25mm diameter) \$59.95ea.

All-Purpose Groover Blade
5875511



Groover Blade for CR-39
5875513



Slotted Blade for Poly & High Index
5875514



For Metal Rimless & Thick Nylon
5875515



5875501 \$428.95/ea.

2 or more \$388.45/ea.

Water-Cooled Hand Edger

- Affordable and easy to use!
- Grooved diamond stone enables you to create a safety bevel
- 1 unit w/tools
- Unit turns on and off automatically
Bring lens close to grinding wheel unit, the wheel will begin to turn. When you are done, pull the lens away and the unit turns itself off.
- One year limited warranty on parts and labor



5875512 **\$475.95/ea.**

2 or More **\$435.95/ea.**

Replacement Hose

5875612 **\$13.95/ea.**

Replacement Belt

5875523 **\$21.95/ea.**

3 Pint Ultrasonic Cleaner

- Cleans up to 6 frames
- Tank dimensions: 6.5"L x 5.25"W x 2.25"D
- 117V - 0.2 Amps; 22 Watts 43 KHz

5874800 **\$119.95/ea.**



1 Pint Ultrasonic Cleaner

- Cleans 1-2 frames
- Tank dimensions: 5.75"L x 3.25"W x 2"D
- 117V - 0.2 Amps; 22 Watts 43 KHz



5874799 **\$69.95/ea.**

2 or More **\$51.95/ea.**

Ultrasonic Solution



- Our ultrasonic solution is very effective for those hard to clean eyeglasses
- It is superconcentrated and requires only 2 ounces to make a full quart

1003332 **\$24.95/ea.**

6 or More **\$19.95/ea.**

12 or More **\$15.95/ea.**



Photochromic Activator



Activate Your Photochromic Lens In a Hurry!

Lens Pro Photochromic Lens Activator will activate any lens manufacturers photochromic lens instantly! Never worry how long will it take for these lens to change color again. Eight UV tubes with reflective inside provide you with the absolute fastest way to activate any photochromic lens material.

- Fastest activation possible
- 8 Ultra violet tubes
- Reflective interior
- Activate multiple pair at once
- Replacement bulbs available

5874504 \$109.95/ea. Photochromic Activator
 5874505 \$10.45/ea. Bulb Replacement

UV Light Meter



- Measures UV to 400nm
- 110 Volt
- 6.75"D x 7"W x 4.25", 4 lbs.
- Appearance of unit might vary
- 1 year limited warranty on parts and labor

5860400 \$310.00/ea.
 2 or More \$259.00/ea.
 4 or More \$210.00/ea.

Progressive Lens Identifier

Enables you to view the progressive markings on lenses much easier.



5874500 \$239.95/ea.
 2 or More \$205.95/ea.



9-Pan Tint Unit



Exclusive Design with External Heating Element to Prevent Leaks and Corrosion

- Designed for better heat distribution and more reliable colors
- 1 year limited warranty
- 14.5" wide x 9" high x 22.5" deep
- Features nine standard 1 quart tanks

Lens Pro 9-Pan Tint Unit
with Chemical Starter Pack

Our Best Value!

Includes \$400 in Chemicals

5869913 **\$999.95**

Lens Pro 9-Pan Tint Unit Only

5869912 **\$749.95**

The complete chemical package contains:

| | | |
|-----------------------|-------------|---------|
| Ultra White UV | 8 oz. conc. | 1400908 |
| Ultra White UV Plus | 8 oz. conc. | 1400910 |
| CR-39 Neutralizer | quart | 1402232 |
| Poly Safe Neutralizer | quart | 1402332 |
| Lens Prep | quart | 1403232 |
| 1 White Lens Holder | | 5860005 |
| 1 Black Lens Holder | | 5860006 |
| Black Dye | 4 oz. conc. | 1406004 |
| Grey Dye | 4 oz. conc. | 1407404 |
| Brown Dye | 4 oz. conc. | 1406104 |
| Sun Grey Dye | 4 oz. conc. | 1407604 |
| Sun Brown Dye | 4 oz. conc. | 1406504 |
| Rose Dye | 4 oz. conc. | 1406804 |
| Pink Dye | 4 oz. conc. | 1406904 |
| Blue Dye | 4 oz. conc. | 1406604 |
| Sky Blue Dye | 4 oz. conc. | 1407004 |
| Green Dye | 4 oz. conc. | 1406304 |
| G15 Dye | 4 oz. conc. | 1407104 |
| Yellow Dye | 4 oz. conc. | 1406204 |
| Heat Transfer Fluid | 4 gallons | 1303001 |



Dual Control Tinting Systems

Heat Up Only What You Need, When You Need It!

You need to do a quick tint, you don't need to heat up that big machine. Our dual control tint machines make tinting easy and efficient. This versatile machine is at home in a lab or retail setting. The exclusive design with easily removable basins makes changing your transfer fluid effortless. If you have ever purchased a new tint machine due to leaky basin you will love our removable basin. You won't be replacing this unit any time soon.

- Easy remove basin for quick clean
- Heat all pans or just half
- Super-Fast heating unit
- Save on chemicals cost
- 1 year warranty



6 Pan System

Available in Six Standard 1 Quart Pan or Twelve Pint Pan Configuration

Dual Control 6 Quart Pan
5869917 \$849.95

Dual Control 12 Pint Pan
5869918 \$1,099.95

NOTE: 20 AMP Breaker is Required for Dual Control Units

Dimensions:
 24" wide x 19" high x 13" deep



12 Pan System



Gradient Systems

4 Stroke w/Digital Timer
5869996 \$469.95

5 Stroke w/Digital Timer
5869995 \$569.95

17 Inch Pole w/Flange
5869990 \$59.95

12 Inch Pole w/Stand
5869994 \$59.95

MINI Gradient System

4 Stroke No Timer
5869997 \$369.95



Space Saver Tinting Systems

The Exclusive Design with Easily Removable Basins
Makes Changing Your Transfer Fluid Effortless



6 Pan System



3 Pan System

Our customers have spoken, we have heard them loud and clear. You asked for a small tinting system. Space Saver Tint systems are far smaller than traditional tint machines, they fit well on a counter or even a cabinet. If you have ever purchased a new tint machine due to leaky basin you will love our removable basin. You won't be replacing this unit any time soon.

- Easy remove basin for quick clean
- Small and compact size
- Super-Fast heating unit
- Save on chemicals costs
- 1 year warranty

Available in Three Standard 1 Quart Pan
or Six Pint Pan Configuration

Lens Pro Space Saver 3 Pan
5869915 \$629.95

Lens Pro Space Saver Mini 6 Pan
5869916 \$749.95

Dimensions:
11" wide x 15" high x 17.5" deep



Easy to remove basin.

Bulbs



**AO/Marco/Topcon
Standard**
Projector 50W 130V 0.39A
8010011 \$17.95



Lensometer
15W 120V 0.125A
8031021 \$8.95
(Sold As 6 Pack)



Align-O-Lens Blocker
25W 6V 4.1A
8091157 \$5.95
(Sold As 6 Pack)



B&L Lensometer
10W 6V 1.67A
8030331 \$5.95
(Sold As 6 Pack)



AIT Blocker
25W 6.2V 3.91A
8013391 \$5.95
(Sold As 6 Pack)



1680 X 25W
6 volt 4.1 amp w/SC B
25W 6V 4.1A
8041680 \$17.95



**Reichert Longlife Selectra/
Woodlyn Projector**
20W 6V 3.33A
8011611 \$19.95



**Topcon L-2D/2E/
1E/4E/7E Slit Lamp**
20W 6V 3.33A
8021321 \$151.95



**Zeiss
Slit Lamp**
25W 6V 4.2A
8020421 \$35.95



**WA 18100 Streak
Retinoscope**
2.45W 3.5V 0.7A
8070761 \$31.95



**WA 18200 Streak
Retinoscope**
2.1W 3.5V 0.6A
8071561 \$27.95



B&L Keratometer
15W 120V 0.125A
8050141 \$5.95
(Sold As 6 Pack)



**Marco Lens Meter #101
Lensometer**
25W 120V 0.21A
8030231 \$5.95
(Sold As 6 Pack)



**WA 11600/
11610/ 11710
Ophthalmoscope**
2.52W 3.5V 0.72A
8080871 \$19.95



**Haag Streit 900/Marco
IIB/ Mentor/Topcon
Slit Lamp**
27W 6V 4.5A
8020121 \$30.95



**Topcon #LM-T#/T5/
3B/3BC/2B/ 6/6E/6S
Lensometer**
15W 120V 0.125A
8031131 \$5.95
(Sold As 6 Pack)



Bulbs



WA 11620/30
1720/30 HAL
2.52W 3.5V 0.72A

8080971 \$27.95

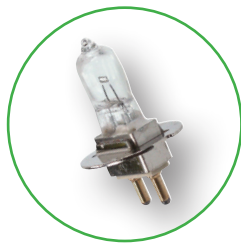

Marco IV/Zeiss 30 SLM,
Niclon FS-2 Slit Lamp
30W 12V 2.5A

8020321 \$35.95



Lensometer Bulb
3W 120V 0.45A

8035500 \$14.95
(For LensPro-5875500)



Nidek Blocker Bulb
5W 4-6V 1.2A

8092510 \$9.95
(Sold As 6 Pack)



AO Lensometer
15W 130V 0.125A

8030431 \$5.95
(Sold As 6 Pack)



Halogen Projector Bulb
20W 12V G6.35

8023511 \$14.95



WA 41100/43300
Transilluminator
2.52W 3.5V 0.72A

8060651 \$16.95



WA 04900
Retinoscope
2.52W 3.5V 0.72A

8074900 \$36.95



AO/Marco/Topcon Std.
Halogen
Projector 50W 130V 0.39A

8011711 \$41.95



Heine Omega
100/150/180/200
Indirect Ophthalmoscope
10W 6V 1.67A

8092081 \$34.95



Keeler
All Pupil & Vantage
Indirect Ophthalmoscope
10W 6V 1.67A

8090381 \$339.95
(2 per package)

*NOTE: All bulbs under \$10.00 are sold as a minimum order of 6 bulbs.



UV Bulbs

| Bulb | Part number | Price |
|---------------|-------------|----------|
| Simplicity UV | 1700003 | \$337.50 |
| Mini 2 UV | 1700005 | \$337.50 |
| EZ Coat UV | 1700004 | \$337.50 |
| MR-3 UV | 1700006 | \$337.50 |
| Velocity UV | 1700040 | \$375.00 |

Series Frame Warmer

- Full temperature and air speed range allows you to use the proper heat setting for trouble free adjustments.
- Compact and quiet unit
- Made in Italy
- 1 year Warranty

5711116 \$425.95



Specifications:
 Maximum temperature: 325°F
 Voltage: 115 volt Watts: 700 Amps: 6
 Dimensions: 8"w x 8-1/2"h x 5-3/4"d

Dynamic Air Frame Warmer



No Messy Beads!
 Ideal for Regular and Sensitive
 Frame Materials

- Generates warm and cold air temperatures
- Reduces danger of burning or drying out frame
- Heat concentration
- 1 year limited warranty on parts and labor

5711006 \$219.95/ea.

2 or more \$199.95/ea.

Replacement Warmer Cup

5711016 \$24.95/ea.

Condenser Cone (Not shown)

5711026 \$24.95/ea.



'HotBox' Salt Pan Frame Warmer



- HOT: Maximum temperature 400°F.
- BIG: Inner pan dimensions 9"w x 2-3/4"h x 5"d.
- CLEAN: Recessed pan is sealed in place so that glass beads or salt will not spill on countertop
- LONG LIFE: Electrical components are shielded from contamination by bead or salt spills
- PLUS: Adjustable temperature control, indicator light, 4' grounded power cord and rubber feet

Dimensions:
 10-5/8"w x 4-1/4"h x 6-1/2"d.
 Electrical Specs: Voltage: 115
 volts Watts: 300 Amps: 2.5

5711216 \$229.95

Glass Beads for Salt Pan

Small Beads
 0.56mm diameter

Large Beads
 1.7-2.0mm diameter

5712005 \$49.95

5712017 \$49.95

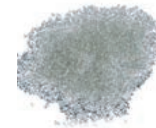

finishing



How To Order Your Choice of Blocking Pads

1. Choose pad material from selection below. (Note 4 digit material code.)



**UltraBlue™
Pads
7022**



**UltraWhite™
Pads
7029**

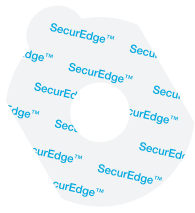

**SecurEdge™
Pads
7021**



**SecurEdge™
Plus Pads
7024**



**BigRED™
Tri-Part Pads
7027**



**LensPRO
Precision Pads
7028**



**ProGRIP2™
Pads
7020**

2. Select pad style. (From next page.)

3. Select quantity. '1' for roll of 1,000 or '2' for roll of 2,000

NOTE: ProGrip2™ only available in roll of 500 ('5')

| UltraBlue™ | UltraWhite™ | SecurEdge™ | SecurEdge™ Plus | BigRED™ | LensPRO Precision | ProGRIP2™ |
|---|-------------|-------------|--------------------|--------------|----------------------|--------------------|
| Roll of 1,000 | | | | | | Roll of 500 |
| \$44.95/ea. | \$44.95/ea. | \$55.95/ea. | \$104.95/ea. | \$64.95/ea. | \$65.95/ea. | \$129.95/ea. |
| 4 or more | | | | | | 4 or more |
| \$41.95/ea. | \$41.95/ea. | \$52.95/ea. | \$94.95/ea. | \$61.95/ea. | \$62.95/ea. | \$119.95/ea. |
| 8 or more | | | | | | 8 or more |
| \$39.95/ea. | \$39.95/ea. | \$49.95/ea. | \$84.95/ea. | \$58.95/ea. | \$59.95/ea. | \$109.95/ea. |
| Roll of 2,000 (Min. of 10 rolls) | | | | | | |
| \$79.90/ea. | \$79.90/ea. | \$99.90/ea. | \$169.90/ea. | \$117.90/ea. | \$119.90/ea. | |

4. How to Specify:

7027 30 2

Brand: Style: Roll Size: 1 = 1000/roll; 2 = 2000/roll; 5 = 500/roll

Example shown reads:
BigRed (7027), 17mm x 24mm half eye (style/shape 30), roll of 2000 (2)



Pad Styles and Measurements

Shape 12 same shape as 3M 1695
3M 1708

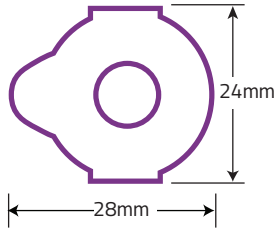

Shape 39

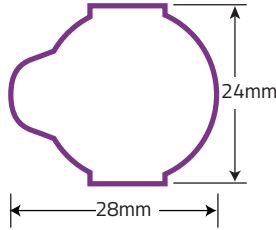

Shape 32 same shape as Gam 200
used on Mr Blue/Orange
edgers

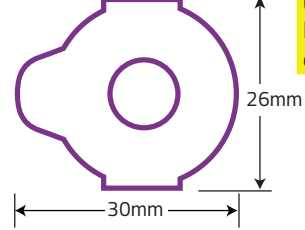

Shape 17 same shape as 3M 1693
For use on
Essilor/Gamma
edgers

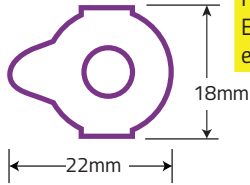

Shape 30

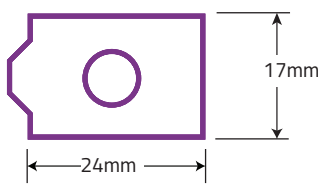

Shape 36 same shape as Gam 403
used on Mr Blue/Orange
edgers

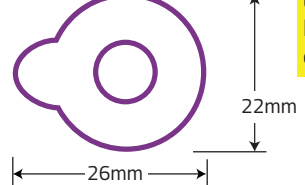

Shape 34 (same shape as 3M 1696)

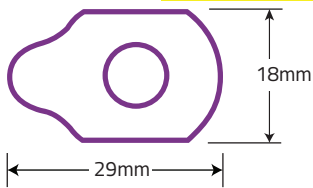

Shape 35

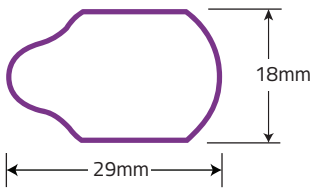

Shape 23 same shape as Gam 316
used on Mr Blue/Orange
edgers

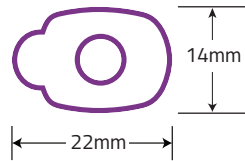

Shape 31 (same shape as 3M 1712NR)

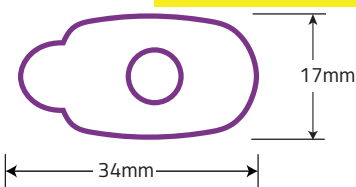

Shape 42

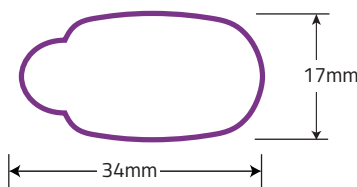

Shape 38

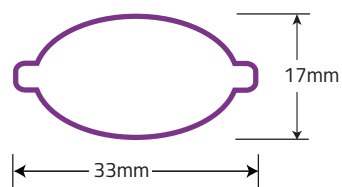

Shape 19

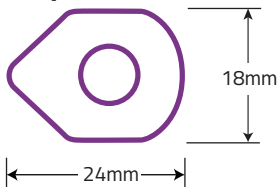

Shape 40

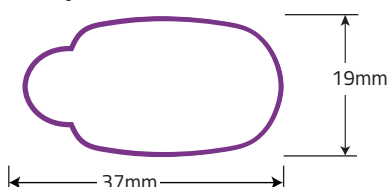

Shape 22

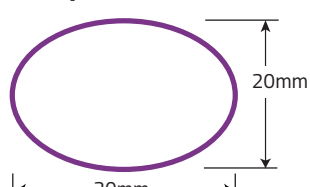

Shape 14 (same shape as 3M 1700)

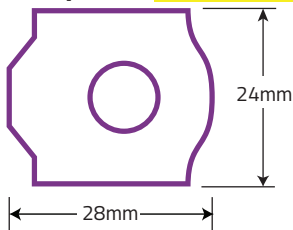

Shape 33

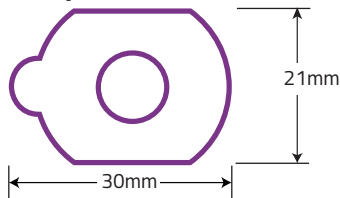

The Right Blocking Pad For The Right Job!



Tri-Part Pads

A Classic High Performance Pad Works Equally Well on AR Coated and Uncoated Lenses

We added a separate anti-twist film between two layers of adhesive to make the pad firmer thus resisting the high torque forces that can cause pads to twist. The Tri-part construction was designed specifically to prevent both slipping and twisting.

All BigRed™ pads start with: **7020**
NOTE: Style 22 NOT available.

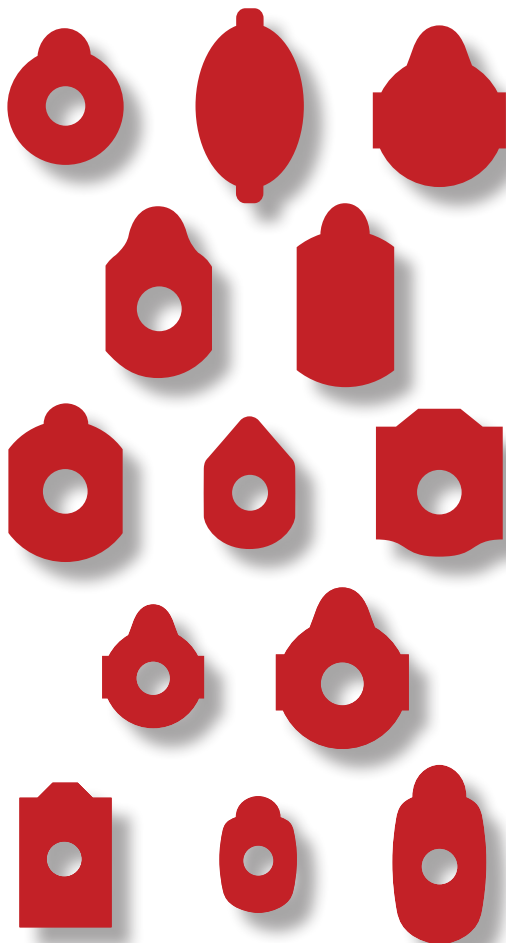

SecurEdge™ Plus Pads

A Blocking Pad Designed Exclusively for Super Hydrophobic AR Lenses

A Dual adhesive system has the strongest adhesive available on the lens side with an easy release adhesive on the block side. This super strong adhesive is designed specifically for AR coated lenses. (It might prove more difficult to remove from non AR coated lenses).

All SecurEdge™ Plus pads start with: **7024**
NOTE: Styles 19, 35, 34, 38, 39 and 40 NOT available.



NEW PRODUCT

ProGRIP2™ Combo Pads

The First Combo Blocking Pad
With a Built-In Anti-Slip Disc!

As lens coatings and materials have become more difficult to edge over the years, we have developed a variety of different blocking pads to solve a myriad of edging problems. The ProGRIP combo pad combines the award winning DynaGrip Xtreme® Anti-Slip Disc with a blocking pad to make the ultimate "One Step Solution". This pad not only eliminates slipping but greatly reduces twisting as well. Holds better than any blocking pad and still releases easily with no adhesive residue. With a quick one step process, it is the easiest and safest way to edge your most expensive lenses.

ProGRIP2™ discs start with: **7020**
Not available in shapes 19 & 22

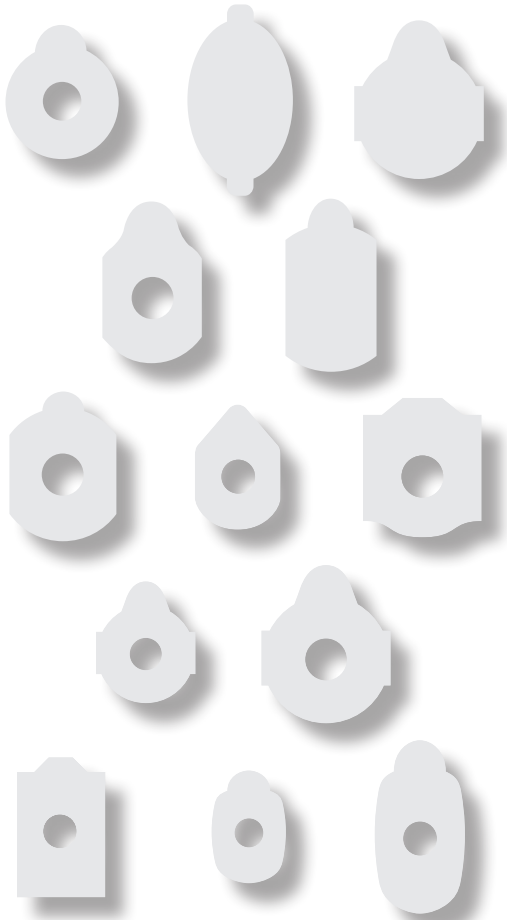

NEW PRODUCT

LensPRO™ PRECISION

Unique Orange Foam Material Will Dramatically
Reduce Twisting in High Torque Edging Situations

LensPro Precision finish blocking pads are your new go to pad. Precision pads work well on coated and uncoated lens. This high tech finish blocking pad eliminates your slippage concerns. Premium coating no problem, our proprietary adhesive allows the pad to stay precisely where you put it. Deblocking is always easy with no unwanted residue. LensPro Precision Pads, precisely are the blocking pads you have been waiting for.

LensPRO™ PRECISION discs start with: **7028**

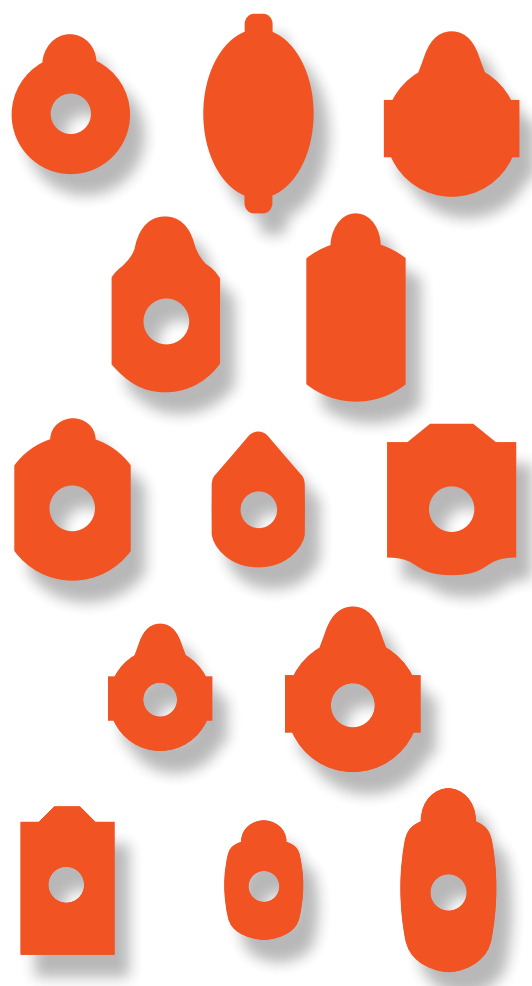

The Right Blocking Pad For The Right Job!

UltraWhite™ Pads

The Classic Blocking Pad That is
Reliable and Economical

Holds well on standard lenses; removes easily without residue.

All Secure Edge™ pads start with: **7029**

NOTE: Style 22 NOT available.

UltraBlue™ Pads

The Original Blue Pad

A sturdy and reliable general purpose blocking pad
that has remained the standard for many years.

All Secure Edge™ pads start with: **7022**

NOTE: Style 22 NOT available.

SecurEdge™ Pads

The Original Blocking Pad Designed
for AR Coated Lenses

This original pad can also be used on uncoated lenses.

All SecurEdge™ pads start with: **7021**

NOTE: Style 22 NOT available.

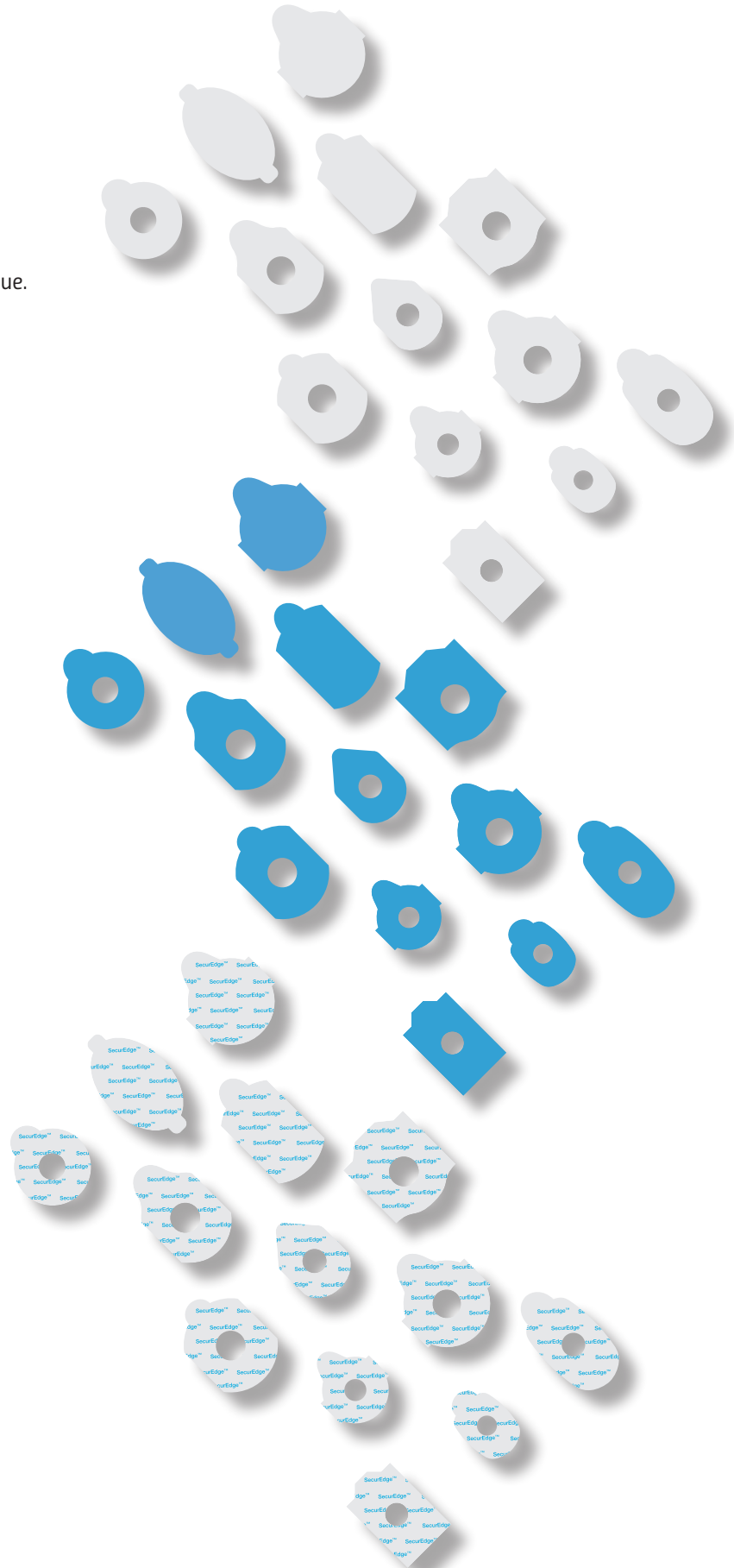

3M Leap Pads

From a Name You Know, With Adhesive and Performance Rivaling Our UltraBlue Pads



Standard Pads

1695

1700

1712NR

1696

1693

1692

403

316



STANDARD PADS

| 3M 1695 | 3M 1700 | 3M 1712NR | 3M 1696 | 3M 1693 | 3M 1692 | GAM 403 | GAM 316 |
|----------------|----------------|----------------|----------------|----------------|----------------|----------------|----------------|
| 2000/roll | 2000/roll | 1000/roll | 1000/roll | 1000/roll | 1000/roll | 1000/roll | 1000/roll |
| 7023112 | 7023132 | 7023311 | 7023341 | 7023171 | 7023121 | 7023361 | 7023231 |
| \$98.95 | \$96.95 | \$92.95 | \$92.95 | \$92.95 | \$96.95 | \$99.95 | \$99.95 |

Same shape as Dynamic Labs Style 12 Blocking Pad

Same shape as Dynamic Labs Style 14 Blocking Pad

Same shape as Dynamic Labs Style 31 Blocking Pad

Same shape as Dynamic Labs Style 34 Blocking Pad

Same shape as Dynamic Labs Style 17 Blocking Pad

Same shape as Dynamic Labs Style 32 Blocking Pad

Same shape as Dynamic Labs Style 36 Blocking Pad

Same shape as Dynamic Labs Style 23 Blocking Pad

Hydrophobic Pads

HYDROPHOBIC PADS

| 3M 1707LSE | 3M 1708LSE | 3M 1712N |
|----------------|----------------|----------------|
| 1000/roll | 1000/roll | per 100 |
| 7023707 | 7023708 | 7031712 |
| \$159.95 | \$159.95 | \$49.95 |

#1707LSE



#1708LSE



#1712N



Blocking Pad Dispenser

For dispensing all sizes and shapes of blocking pads.

7011001 \$38.95/ea.

2 or more \$32.95/roll

4 or more \$29.95/roll

Put An End To Blocking Pad Slippage On Super-Hydrophobic Lenses!



The Newest Weapon in Your Arsenal
to Protect Your Costly Lens Investment

Tired of ruining lens? Blocking pads failed you? Anti-slip films leaving you on a slippery slope?

Lens Pro™ Traction Control to the rescue!

Simply apply one or two sprays to the coated lens.
Allow 30-60 seconds for product to dry, then block and edge.
To remove product simply spray with Eliminator, and wipe with
a clean lens cloth.

- Temporary top coat
- Simple application-fast dry
- Available in 1 and 4 ounce spray bottles

7031004 **4 Ounces** \$99.95/ea.

7031001 **1 Ounce** \$34.95/ea.



3M Anti-Slip Discs

Package of 500 pads



7031705 \$79.95/package

6 or more \$71.95/package

Armor™ No-Slip Pads

Roll of 2000 pads

Size: 20mm x 40mm

7031112 \$129.95/roll

6 or more \$109.95/roll

12 or more \$99.95/roll



Award Winning and Proven Anti-Slip Technology



A Premium Anti-Slip Film

DynaGRIP™ Xtreme utilizes all of the proven and award winning technology of DynaGRIP™ with the added features of:

- GRIPIT™ technology that provides the strongest adhesion, yet is easily removed when the job is complete
- Clear – so there's never any issue seeing lens markings through the film by the operator or equipment
- 25mm x 38mm available in solid oval and with center hole
- 500 pads per roll

Oval Solid

7033841 \$95.95/roll
4 or more \$89.95/roll
8 or more \$84.95/roll

Oval With Center Hole

7033842 \$95.95/roll
4 or more \$89.95/roll
8 or more \$84.95/roll



Blocks

All blocks packaged in bags of 10 blocks

Coburn 17x24mm; 24mm dia.

METAL 3M part #1683-CO



7043811
High Base / Full
\$49.95

METAL 3M part #1682-CO



7043411
Low Base / Full
\$49.95

METAL 3M part #1685-CO



7043621
Base 6 / Half Eye
\$49.95

METAL 3M part #1678-CO



7043611
Base 6 / Full
\$49.95

METAL 3M part #1683-CO



7043821
High Base / Half Eye
\$49.95

Semi-Tech 17x24mm; 24mm dia.

METAL 3M part #1682-ST



7048421
Low Base / Half Eye
\$49.95

METAL 3M part #1682-ST



7048411
Low Base / Full
\$49.95

METAL 3M part #1678-ST



7048611
Base 6 / Full
\$49.95

METAL 3M part #1683



7048821
High Base / Half Eye
\$49.95

AIT 17x24mm; 24mm dia.

METAL 3M part #1682-A



7040421
Low Base / Half Eye
\$49.95

METAL 3M part #1682-A



7040411
Low Base / Full
\$49.95

METAL 3M part #1678-A



7040611
Base 6 / Full
\$49.95

METAL 3M part #1683-A



7040821
High Base / Half Eye
\$49.95

Shuron 17x24mm; 24mm dia.

METAL 3M part #1682-S



7080411
Low Base / Full
\$49.95

METAL 3M part #1678-S



7080611
Base 6 / Full
\$49.95

PLASTIC



7080623
Base 6 / Half Eye
\$42.95

PLASTIC



7080613
Base 6 / Full
\$42.95

Essilor 18mm dia.

RIGID



7054213
Half Eye
\$32.95

FLEXIBLE



7054215
Half Eye
\$32.95

Gamma 17mm x 24mm; 24mm dia.

PLASTIC



7055633
Micro
\$32.95

PLASTIC



7055623
Half Eye
\$32.95

PLASTIC



7055613
Full
\$32.95

Nidek/Santinelli 70/70 20x26mm; 24mm dia.

PLASTIC



7063623
Half Eye
\$42.95

PLASTIC



7063613
Full
\$42.95

Nidek/Santinelli 1000/9000/1200

PLASTIC



7059623
Half Eye / 18x24mm
\$35.95

PLASTIC

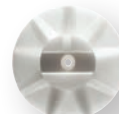

7059613
Full / 24mm dia.
\$35.95

FLEXIBLE



7059625
Half Eye / 17x30mm
\$35.95



Blocks

All blocks packaged in bags of 10 blocks

Coburn 17x24mm; 24mm dia.

FLEXIBLE



7043615
Base 6 / Full
\$42.95

PLASTIC



7043623
Base 6 / Half Eye
\$42.95

PLASTIC



7043613
Base 6 / Full
\$42.95

Semi-Tech 17x24mm; 24mm dia.

METAL 3M part #1683-ST



7048811
High Base / Full
\$49.95

PLASTIC



7048623
Base 6 / Half Eye
\$42.95

PLASTIC



7048613
Base 6 / Full
\$42.95

FLEXIBLE



7048615
Base 6 / Full
\$42.95

AIT 17x24mm; 24mm dia.

METAL 3M part #1683-A



7040811
High Base / Full
\$49.95

PLASTIC



7040623
Base 6 / Half Eye
\$32.95

PLASTIC



7040613
Base 6 / Full
\$32.95

FLEXIBLE



7040615
Base 6 / Full
\$32.95

Weco 20x26mm; 24mm dia.

FIRM



7050223
Low Base / Half Eye
\$32.95

FIRM



7050213
Low Base / Full
\$32.95

FIRM



7050623
Base 6 / Half Eye
\$32.95

FIRM



7050613
Base 6 / Half Eye
\$32.95



7081718
18mm
\$49.95



7087125
25mm
\$49.95



7081717
17mm / Half Eye
\$49.95

Nidek Style Blocks

PLIABLE



7059626
Oval / 17 x30
\$32.95

PLIABLE



7059627
Oval / 17 x30
\$32.95

LensPRO Scratchless LMU Feeler Tips for Santinelli Nidek

LE1000, LE1200, LE1200, LEX1000, LEX1200

7090001
Sold as a Pair
\$150.95/1 Pair



Leftside



Rightside

Briot

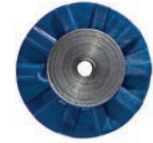

7051725
25mm
\$74.95



7051719
19mm
\$74.95

Huvitz



7081613
High Base 20 x 17.5
\$32.95

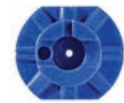

7081623
Low Base 20 x 17.5
\$32.95



7081633
24 x 17
\$32.95

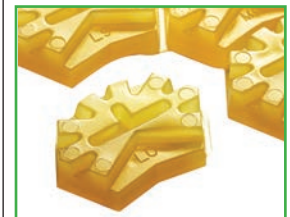

Wax Blocks

Box of 1000

7046616 \$149.95/box
2 or more \$139.95/ea.
4 or more \$129.95/ea.

AR Markers

Specifically Formulated to Write on Today's Anti-Reflective Coatings

- Black**
7371924 \$6.95/ea.
12 or more \$5.95/ea.
25 or more \$4.95/ea.
- Red**
7371923 \$6.95/ea.
12 or more \$5.95/ea.
25 or more \$4.95/ea.
- White**
7371925 \$9.95/ea.
12 or more \$8.95/ea.
25 or more \$7.95/ea.



China Markers

- Bright and legible through normal lab operations
- Waterproof wax markers
- 12 per box

- White**
7300001 \$17.95/box
- Red**
7300002 \$17.95/box
- Black**
7300008 \$17.95/box



Vis-a-Vis Marker

Package of 3

- Black**
7310008 \$6.95/ea.
- Blue**
7310009 \$6.95/ea.



Expo Dry-Erase Marker

Package of 3

- Fine Black**
7310018 \$4.95/ea.



Edge Color Pens

Apply Edge Coating to Match a Frame

- Great for use on lens in a semi rimless frame
- Use on a high plus or high minus lens
- Add a personal flare or eliminate glare from all types of eyewear with these 11 terrific colors!

Kit With 12 Pens
7399911 \$299.95/kit

Individual Pens
See chart below \$29.95/box



| | | | | | |
|--|--------|---------|--|-----------|---------|
| | Grey | 7399900 | | Fuchsia | 7399906 |
| | Black | 7399901 | | Lilac | 7399907 |
| | Green | 7399902 | | Violet | 7399908 |
| | Yellow | 7399903 | | Turquoise | 7399909 |
| | Brown | 7399904 | | Blue Mist | 7399910 |
| | Plum | 7399905 | | Corrector | 7399920 |



Armor™ Oval Felt Backing Pad

20 x 30 Oval Pads
Roll of 1000 Pads



7031085 \$109.95/ea.
4 or more \$99.95/ea.
8 or more \$99.95/ea.

3M Chip Pads



3M #1647 Blue Chip Pads

Roll of 2000 Pads

7031402 \$89.95/ea.
4 or more \$84.95/ea.

3M #1647C Clear Chip Pads

Roll of 2000 Pads

7031411 \$99.95/ea.
4 or more \$95.95/ea.



Armor™ Center Protectors



1.5" Blue Round

Roll of 2000 Pads

7032351 \$79.95/ea.
2 or more \$74.95/ea.
4 or more \$69.95/ea.



1.5" Clear Round

Roll of 2000 Pads

7031351 \$89.95/ea.
4 or more \$84.95/ea.
8 or more \$79.95/ea.



1" Blue Round

Roll of 2000 Pads

7032311 \$68.95/ea.
4 or more \$63.95/ea.
8 or more \$58.95/ea.



1" Clear Round

Roll of 2000 Pads

7031311 \$68.95/ea.
4 or more \$63.95/ea.
8 or more \$58.95/ea.

National Optronics Blades for All Your Needs

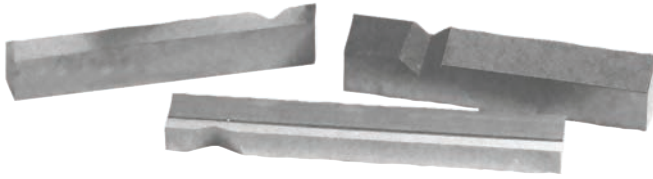

Standard Blades for National Optronics 6E/ 7E

- 300 cuts per blade
- 10 blades per package

7097044 \$120.95/per package
5 or more \$89.95/per package

Shallow Bevel Blade for National Optronics 6E/7E

- 300 cuts per blade
- 1 blade per package

7097444 \$120.95/per package

High Wrap Blade for National Optronics 6E/7E

- 300 cuts per blade
- 1 blade per package

7097065 \$49.95/per package

National Optronics 2 Blades

- 300 cuts per blade
- 10 blades per package

7097062 \$120.95/per package
5 or more \$89.95/per package

National Optronics 3 Blades

- 300 cuts per blade
- 10 blades per package

7097061 \$120.95/per package
5 or more \$89.95/per package

For National Optronics 7E Edgers

Triple Life 900 Cut Disposable Blades

- 10 blades per package

7097043 \$269.95/per package
5 or more \$220.95/per package

10,000 Cut Disposable Blades

- 10 blades per package

7097045 \$420.95/per package

Horizon 2 Extended Life Blades

- 10 blades per package

7097042 \$295.95/per package



Horizon 3 Extended Life Blades

- 10 blades per package

7097063 \$295.95/per package



Dressing Sticks

With the proper grit for dressing, trueing, roughing and finishing diamond wheels. 1/2"x1/2"x 6".



Tan for Roughing
80 grit 7210404

White for Finishing
220 grit 7210406

\$9.95/ea.

Pattern Blanks

- Use in automatic pattern makers or cut by hand
- 80mm x 65mm.
1.8mm thick

Solid

- 100 per bag

7480651 \$24.95/ea.
4 or more \$19.95/ea.
8 or more \$17.95/ea.

Black Grid On White

- 50 per bag

7480655 \$29.95/ea.

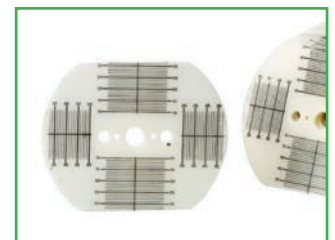

Edging Wheels

All Edger Wheels Are Sold As Final Sale and Are Non-Returnable

Standard Roughing Wheel

Our high quality standard roughing wheels are designed to outlast and outperform those provided by the OEM, at a fraction of the cost. Our diamond wheels are available for glass, plastic, polycarbonate, and Hi index lenses.



Trivex Roughing Wheel

Our new Trivex roughing wheel is specifically designed to control the high heat often generated while edging Trivex material. This slotted wheel will reduce the surface temperature of both the wheel and the lens. This allows you to cut Trivex material quickly and efficiently. Whether you're in a production lab or small office, this is the best way to cut Trivex lenses.



Finishing Wheel

Our finishing wheels are manufactured to provide you with the finest quality product at a fraction of the cost of those offered by the OEM.



Polishing Wheel

Our polishing wheels provide you with the high luster shine. Our finishing and polishing wheels are available as a set.

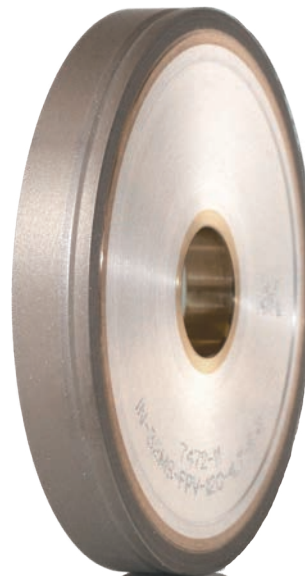

How do you know when it is time to change the wheels on your edger?

For roughing wheels, watch for these symptoms: Wheel is not cutting or is working slower, has axis problems, or lens slippage. If you have used the same blocking pad for years with good result, and no other conditions in your edging process have changed, it may be time for new edger wheels. You can NOT use dressing sticks on your roughing wheels.

For finishing and polishing wheels – if it is taking too long, or the bevel looks more like a “U” instead of a “V”, you can try dressing it with a dressing stick for finishing wheels. The more it is used, the deeper the U area and eventually there is no diamond bond left. It's time to change the wheel.

| Description | SKU# | Price |
|--|---------|----------|
| AIT MARK IV, V, GM (old models) | | |
| AIT MARK V ROUGHING WHEEL FOR GLASS 15mm | 7091007 | \$294.95 |
| AIT MARK V ROUGHING WHEEL FOR GLASS/POLY/PLASTIC 15mm | 7091008 | \$294.95 |
| AIT MARK V ROUGHING WHEEL BRAZED FOR POLY/PLASTIC 15mm | 7091009 | \$290.95 |
| AIT GRANDE MARK ROUGHING WHEEL FOR GLASS/POLY/PLASTIC 21mm | 7091010 | \$313.95 |
| AIT GRANDE MARK ROUGHING WHEEL BRAZED FOR POLY/PLASTIC 21mm | 7091011 | \$313.95 |
| AIT GRANDE MARK ROUGHING WHEEL BRAZED FOR TRIVEX/POLY/PLASTIC 21mm | 7091012 | \$335.95 |
| AIT OPTIVUE ROUGHING WHEEL FOR GLASS 21mm | 7091013 | \$313.95 |
| AIT MARK IV + MARK V ROUGHING WHEEL FOR GLASS 15mm | 7091014 | \$329.95 |
| AIT MARK IV + MARK V ROUGHING WHEEL FOR GLASS 21mm | 7091015 | \$369.95 |
| AIT MARK V FINISHING WHEEL FLAT 15mm | 7091116 | \$399.95 |
| AIT MARK V FINISHING WHEEL 4-ANGLE 15mm | 7091118 | \$399.95 |
| AIT GRANDE MARK FINISHING WHEEL 4 ANGLE 21mm | 7091218 | \$429.95 |
| AIT MARK V FINISHING WHEEL 4 ANGLE 21mm | 7091318 | \$429.95 |

| | | |
|--|---------|----------|
| BRIOT (old models) | | |
| BRIOT ROUGHING WHEEL FOR GLASS 15mm | 7095038 | \$359.95 |
| BRIOT ROUGHING WHEEL FOR GLASS 18mm | 7095116 | \$359.95 |
| BRIOT ROUGHING WHEEL BRAZED FOR POLY/PLASTIC 18mm | 7095218 | \$329.95 |
| BRIOT ROUGHING WHEEL FOR GLASS 22mm | 7095318 | \$399.95 |
| BRIOT ROUGHING WHEEL BRAZED FOR POLY/PLASTIC 20mm | 7095338 | \$399.95 |
| BRIOT FINISHING WHEEL 4-ANGLE FOR ALL MATERIALS 12mm | 7095452 | \$329.95 |
| BRIOT FINISHING WHEEL FLAT-V FOR ALL MATERIALS 20mm | 7095037 | \$379.95 |
| BRIOT FINISHING WHEEL 4-ANGLE FOR GLASS 20mm | 7095036 | \$379.95 |
| BRIOT FINISHING WHEEL 4-ANGLE FOR GLASS 22mm | 7095035 | \$399.95 |

| | | |
|--|---------|----------|
| BRIOT ACCURA & BRIOT ALTA | | |
| BRIOT ACCURA ROUGHING WHEEL FOR GLASS 16mm | 7095034 | \$355.95 |
| BRIOT ACCURA ROUGHING WHEEL FOR POLY/PLASTIC 16mm | 7095033 | \$345.95 |
| BRIOT ACCURA ROUGHING WHEEL BRAZED FOR POLY/PLASTIC 20mm | 7095212 | \$349.95 |

All Edger Wheels Are Sold As Final Sale and Are Non-Returnable



| Description | SKU# | Price |
|--|---------|----------|
| BRIOT ACCURA & BRIOT ALTA (Cont'd) | | |
| BRIOT ACCURA ROUGHING WHEEL BRAZED FOR TRIVEX/POLY/PLASTIC 20mm | 7095032 | \$360.95 |
| BRIOT ALTA ROUGHING WHEEL FOR GLASS 16mm | 7095031 | \$299.95 |
| BRIOT ALTA ROUGHING WHEEL FOR POLY/PLASTIC 18mm | 7095030 | \$266.95 |
| BRIOT ALTA ROUGHING WHEEL FOR TRIVEX/POLY/PLASTIC 18mm | 7095029 | \$369.95 |
| BRIOT ALTA PRO (6500rpm) ROUGHING WHEEL BRAZED FOR POLY/PLASTIC 20mm | 7095028 | \$349.95 |
| BRIOT ALTA PRO (6500 rpm) ROUGHING WHEEL BRAZED FOR TRIVEX/POLY/PLASTIC 20mm | 7095312 | \$335.95 |
| BRIOT ACCURA FINISHING WHEEL FLAT-V FOR ALL MATERIALS 18mm | 7095238 | \$355.95 |
| BRIOT ACCURA POLISHING WHEEL FLAT-V 18mm | 7095058 | \$379.95 |
| BRIOT ACCURA 18mm FINISHING AND 18mm POLISHING MATCHED SET | 7095027 | \$599.95 |
| BRIOT ALTA FINISHING WHEEL FLAT-V FOR ALL MATERIALS 18mm | 7095026 | \$369.95 |
| BRIOT ALTA POLISHING WHEEL FLAT-V 18mm | 7095025 | \$335.95 |
| BRIOT EMOTION | | |
| BRIOT EMOTION ROUGHING WHEEL 18mm POLY/PLASTIC/TRIVEX | 7050926 | \$379.95 |
| ESSILOR Kappa, Gamma, Triumph, Spartan, Profile, etc. | | |
| ESSILOR ROUGHING WHEEL FOR GLASS 15mm | 7092115 | \$469.95 |
| ESSILOR ROUGHING WHEEL BRAZED FOR POLY/PLASTIC 15mm | 7092302 | \$549.95 |
| ESSILOR ROUGHING WHEEL BRAZED FOR TRIVEX/POLY/PLASTIC 15mm | 7092015 | \$569.95 |
| ESSILOR POLISHING WHEEL FOR GLASS 22mm, V BEVEL | 7092022 | \$469.95 |
| ESSILOR ROUGHING WHEEL BRAZED FOR POLY/PLASTIC 22mm | 7092212 | \$379.95 |
| ESSILOR ROUGHING WHEEL BRAZED FOR TRIVEX/POLY/PLASTIC 22mm | 7092415 | \$379.95 |
| ESSILOR POLISHING WHEEL FLAT-V 15mm | 7092025 | \$589.95 |
| ESSILOR FINISHING WHEEL FLAT-V FOR GLASS 22mm | 7092312 | \$469.95 |
| ESSILOR FINISHING WHEEL FLAT-V FOR ALL MATERIALS 22mm | 7092032 | \$469.95 |
| ESSILOR POLISHING WHEEL FLAT-V 22mm | 7092022 | \$469.95 |
| ESSILOR 22mm FINISHING AND 15mm POLISHING FLAT-V MATCHED SET | 7092331 | \$989.95 |
| ESSILOR 22mm FINISHING AND 22mm POLISHING FLAT-V MATCHED SET | 7092332 | \$989.95 |
| GERBER Professional | | |
| GERBER ROUGHING WHEEL FOR GLASS 19mm | 7096011 | \$339.95 |
| GERBER ROUGHING WHEEL FOR GLASS 21mm | 7096010 | \$349.95 |
| GERBER ROUGHING WHEEL FOR POLY/PLASTIC 21mm | 7096009 | \$349.95 |
| GERBER ROUGHING WHEEL FOR TRIVEX/POLY/PLASTIC 21mm | 7096008 | \$369.95 |

All Edger Wheels Are Sold As Final Sale and Are Non-Returnable

| Description | SKU# | Price |
|---|---------|----------|
| GERBER Professional (cont'd) | | |
| GERBER FINISHING WHEEL 4-ANGLE FOR ALL MATERIALS 19mm | 7096005 | \$369.95 |
| GERBER FINISHING WHEEL 4-ANGLE FOR GLASS 19mm | 7096004 | \$369.95 |
| GERBER FINISHING WHEEL 4-ANGLE FOR GLASS 21mm | 7096003 | \$409.95 |
| GERBER FINISHING WHEEL 4-ANGLE FOR ALL MATERIALS 21mm | 7096002 | \$409.95 |
| GERBER POLISHING WHEEL 4-ANGLE 17mm | 7096001 | \$589.95 |
| GERBER POLISHING WHEEL 4-ANGLE 21mm | 7096000 | \$589.95 |

| | | |
|---|---------|----------|
| HUVITZ Excelon (not for 7000 & 8000 HD models) | | |
| HUVITZ ROUGHING WHEEL FOR GLASS 17mm | 7098418 | \$349.95 |
| HUVITZ ROUGHING WHEEL FOR TRIVEX/POLY/PLASTIC 17mm | 7098416 | \$359.95 |
| HUVITZ FINISHING WHEEL 4-ANGLE FOR ALL MATERIALS 17.5mm | 7098415 | \$359.95 |
| HUVITZ FINISHING WHEEL FLAT-V FOR ALL MATERIALS 17.5mm | 7098414 | \$359.95 |
| HUVITZ POLISHING WHEEL 4-ANGLE 17.5mm | 7098413 | \$589.95 |
| HUVITZ POLISHING WHEEL FLAT-V 17.5mm | 7098412 | \$589.95 |
| HUVITZ GROOVING BLADE NO SLOTS METAL BOND 20mm | 7098411 | \$96.95 |
| HUVITZ SAFETY BEVELING WHEEL 26.1mm | 7098410 | \$150.95 |

| | | |
|---|---------|----------|
| INDO Maxima, Practica (aka AIT Maxima, Practica) | | |
| INDO ROUGHING WHEEL FOR GLASS 16mm | 7091030 | \$329.95 |
| INDO ROUGHING WHEEL BRAZED FOR POLY/PLASTIC 16mm | 7091031 | \$329.95 |
| INDO ROUGHING WHEEL FOR GLASS 19mm | 7091032 | \$329.95 |
| INDO ROUGHING WHEEL BRAZED FOR POLY/PLASTIC 19mm | 7091033 | \$329.95 |
| INDO ROUGHING WHEEL BRAZED FOR TRIVEX/POLY/PLASTIC 19mm | 7091034 | \$389.95 |
| INDO FINISHING WHEEL FLAT-V FOR GLASS 16mm | 7091035 | \$349.95 |
| INDO FINISHING WHEEL FLAT-V FOR ALL MATERIALS 16mm | 7091036 | \$349.95 |
| INDO POLISHING WHEEL FLAT-V 16mm | 7091025 | \$589.95 |

| | | |
|--|---------|----------|
| NIDEK, all models | | |
| NIDEK ROUGHING WHEEL FOR GLASS 12mm | 7093117 | \$299.95 |
| NIDEK ROUGHING WHEEL BRAZED FOR POLY/PLASTIC 12mm | 7093227 | \$319.95 |
| NIDEK ROUGHING WHEEL BRAZED FOR TRIVEX/POLY/PLASTIC 12mm | 7093312 | \$319.95 |
| NIDEK ROUGHING WHEEL FOR GLASS 17mm | 7093317 | \$309.95 |
| NIDEK ROUGHING WHEEL BRAZED FOR POLY/PLASTIC 17mm | 7093315 | \$309.95 |
| NIDEK ROUGHING WHEEL FOR TRIVEX/POLY/PLASTIC 17mm | 7093217 | \$329.95 |
| NIDEK ROUGHING WHEEL FOR GLASS 23mm | 7093333 | \$329.95 |
| NIDEK ROUGHING WHEEL BRAZED FOR POLY/PLASTIC 23mm | 7093212 | \$329.95 |
| NIDEK ROUGHING WHEEL FOR TRIVEX/POLY/PLASTIC 23mm | 7093337 | \$355.95 |

All Edger Wheels Are Sold As Final Sale and Are Non-Returnable



| Description | SKU# | Price |
|---|---------|----------|
| NIDEK, all models (cont'd) | | |
| NIDEK 9090 ROUGHING WHEEL BRAZED FOR POLY/PLASTIC 22mm | 7093334 | \$379.95 |
| NIDEK LEX- 1000 ROUGHING WHEEL BRAZED FOR POLY/PLASTIC 17mm | 7093017 | \$449.95 |
| NIDEK ME- 1200 ROUGHING WHEEL BRAZED FOR POLY/PLASTIC 21mm | 7093338 | \$329.95 |
| NIDEK ME- 1200 ROUGHING WHEEL BRAZED FOR TRIVEX/POLY/PLASTIC 21mm | 7093339 | \$399.95 |
| NIDEK FINISHING WHEEL 4-ANGLE FOR ALL MATERIALS 17.5mm | 7093237 | \$319.95 |
| NIDEK POLISHING WHEEL 4-ANGLE 17.5mm | 7093027 | \$389.95 |
| NIDEK FINISHING WHEEL 4-ANGLE FOR GLASS 23mm | 7093310 | \$379.95 |
| NIDEK FINISHING WHEEL 4-ANGLE FOR ALL MATERIALS 23mm | 7093232 | \$389.95 |
| NIDEK 17.5mm FINISHING AND 17.5mm POLISHING MATCHED SET 4-ANGLE | 7093311 | \$599.95 |
| NIDEK 9090 FINISHING WHEEL 4-ANGLE FOR ALL MATERIALS 18mm | 7093313 | \$299.95 |
| NIDEK 9090 POLISHING WHEEL 4-ANGLE 18mm | 7093314 | \$299.95 |

| NOVAMATIC / TAKUBO | | |
|---|---------|----------|
| NOVA / TAKUBOMATIC ROUGHING WHEEL FOR GLASS 18mm | 7096020 | \$339.95 |
| NOVA / TAKUBOMATIC ROUGHING WHEEL BRAZED FOR POLY/PLASTIC 18mm | 7096021 | \$339.95 |
| NOVA / TAKUBOMATIC ROUGHING WHEEL BRAZED FOR TRIVEX/POLY/PLASTIC 18mm | 7096022 | \$359.95 |
| NOVA / TAKUBOMATIC ROUGHING WHEEL FOR GLASS 22mm | 7096023 | \$399.95 |
| NOVA / TAKUBOMATIC ROUGHING WHEEL BRAZED FOR POLY/PLASTIC 22mm | 7096024 | \$399.95 |
| NOVA / TAKUBOMATIC ROUGHING WHEEL FOR GLASS/POLY/PLASTIC 22mm | 7096026 | \$399.95 |
| NOVA / TAKUBOMATIC ROUGHING WHEEL BRAZED FOR TRIVEX/POLY/PLASTIC 22mm | 7096027 | \$399.95 |
| NOVA / TAKUBOMATIC FINISHING WHEEL 4-ANGLE FOR GLASS 14mm | 7096028 | \$299.95 |
| NOVA / TAKUBOMATIC FINISHING WHEEL 4-ANGLE FOR ALL MATERIALS 14mm | 7096029 | \$335.95 |
| NOVA / TAKUBOMATIC FINISHING WHEEL FLAT-V FOR ALL MATERIALS 18mm | 7096030 | \$335.95 |
| NOVA / TAKUBOMATIC FINISHING WHEEL 4-ANGLE FOR ALL MATERIALS 22mm | 7096031 | \$349.95 |

| TOPCON | | |
|---|---------|----------|
| TOPCON ROUGHING WHEEL 18mm BRAZED BOND FOR POLY/PLASTIC/TRIVEX | 7099037 | \$379.95 |
| TOPCON FINISHING WHEEL 18mm, ALL MATERIALS, 4 ANGLE, 110 DEGREE BEVEL | 7099038 | \$379.95 |
| TOPCON POLISHING WHEEL 18mm, ALL MATERIALS, 4 ANGLE, 110 DEGREE BEVEL | 7099039 | \$429.95 |

All Edger Wheels Are Sold As Final Sale and Are Non-Returnable

| Description | SKU# | Price |
|--|---------|----------|
| WECO, all models | | |
| WECO ROUGHING WHEEL 15mm FOR GLASS | 7099001 | \$339.95 |
| WECO ROUGHING WHEEL 15mm BRAZED FOR POLY/PLASTIC | 7099002 | \$339.95 |
| WECO ROUGHING WHEEL 15mm BRAZED FOR TRIVEX/POLY/PLASTIC | 7099003 | \$339.95 |
| WECO ROUGHING WHEEL NO UNDERCUT 18mm FOR GLASS | 7099004 | \$339.95 |
| WECO ROUGHING WHEEL NO UNDERCUT 18mm BRAZED FOR POLY/PLASTIC | 7099005 | \$339.95 |
| WECO ROUGHING WHEEL WITH UNDERCUT 18mm FOR GLASS | 7099006 | \$339.95 |
| WECO ROUGHING WHEEL WITH UNDERCUT 18mm BRAZED FOR POLY/PLASTIC | 7099007 | \$339.95 |
| WECO ROUGHING WHEEL 18mm BRAZED FOR TRIVEX/POLY/PLASTIC | 7099008 | \$359.95 |
| WECO ROUGHING WHEEL WITH UNDERCUT 20mm FOR GLASS | 7099009 | \$349.95 |
| WECO ROUGHING WHEEL WITH UNDERCUT 20mm BRAZED FOR POLY/PLASTIC | 7099010 | \$349.95 |
| WECO ROUGHING WHEEL NO UNDERCUT 20mm FOR GLASS | 7099011 | \$349.95 |
| WECO ROUGHING WHEEL 20mm BRAZED FOR POLY/PLASTIC | 7099012 | \$349.95 |
| WECO ROUGHING WHEEL 20mm BRAZED FOR TRIVEX/POLY/PLASTIC | 7099013 | \$389.95 |
| WECO ROUGHING WHEEL NO UNDERCUT 22mm FOR GLASS | 7099014 | \$385.95 |
| WECO ROUGHING WHEEL WITH UNDERCUT 22mm FOR GLASS | 7099015 | \$385.95 |
| WECO ROUGHING WHEEL FOR E.1/E.3 18mm POLY/PLASTIC/TRIVEX | 7050926 | \$379.95 |
| WECO POLISHING WHEEL FLAT 10mm | 7099016 | \$319.95 |
| WECO FINISHING WHEEL 4-ANGLE FOR GLASS 15mm | 7099017 | \$345.95 |
| WECO FINISHING WHEEL 4-ANGLE FOR ALL MATERIALS 15mm | 7099018 | \$355.95 |
| WECO FINISHING WHEEL FLAT FOR GLASS 15mm | 7099019 | \$345.95 |
| WECO FINISHING WHEEL FLAT FOR ALL MATERIALS 15mm | 7099020 | \$355.95 |
| WECO POLISHING WHEEL FLAT 15mm | 7099021 | \$369.95 |
| WECO POLISHING WHEEL 4-ANGLE 15mm | 7099022 | \$369.95 |
| WECO FINISHING WHEEL 4-ANGLE FOR GLASS 18mm | 7099023 | \$349.95 |
| WECO FINISHING WHEEL 4-ANGLE FOR ALL MATERIALS 18mm | 7099024 | \$355.95 |
| WECO FINISHING WHEEL 4-ANGLE FOR GLASS 20mm | 7099025 | \$355.95 |
| WECO FINISHING WHEEL 4-ANGLE FOR ALL MATERIALS 20mm | 7099030 | \$349.95 |
| WECO POLISHING WHEEL 4-ANGLE 20mm | 7099026 | \$389.95 |
| WECO FINISHING WHEEL 4-ANGLE FOR GLASS 22mm | 7099027 | \$359.95 |
| WECO FINISHING WHEEL 4-ANGLE FOR GLASS 25mm | 7099028 | \$429.99 |
| WECO FINISHING WHEEL 4-ANGLE FOR ALL MATERIALS 25mm | 7099029 | \$399.95 |
| WECO 15mm FINISHING AND 15mm POLISHING 4-ANGLE MATCHED SET | 7099032 | \$608.95 |
| WECO 20mm FINISHING AND 15mm POLISHING 4-ANGLE MATCHED SET | 7099034 | \$624.95 |

All Edger Wheels Are Sold As Final Sale and Are Non-Returnable



Job Trays



Standard Job Trays

| Color | Tray # | Color | Tray # |
|--------|---------|-------|---------|
| Purple | 5969111 | Green | 5969151 |
| Yellow | 5969121 | Blue | 5969161 |
| Ivory | 5969131 | Gray | 5969171 |
| Red | 5969141 | Black | 5969181 |

- Stackable
- Removable partition
- 6"W x 9"L x 1.5"D

\$3.95 each

Standard Job Trays by the Case

| Color | Tray # | Color | Tray # |
|--------|---------|-------|---------|
| Purple | 5969114 | Green | 5969154 |
| Yellow | 5969124 | Blue | 5969164 |
| Ivory | 5969134 | Gray | 5969174 |
| Red | 5969144 | Black | 5969184 |

\$69.95/case of 24 (One color per case)

Large Job Trays

| Color | Tray # | Color | Tray # |
|--------|---------|-------|---------|
| Purple | 5969211 | Green | 5969251 |
| Yellow | 5969221 | Blue | 5969261 |
| Ivory | 5969231 | Gray | 5969271 |
| Red | 5969241 | Black | 5969281 |

- Stackable
- 7"W x 12"L x 2"D

\$6.95 each

Large Job Trays by the Case

| Color | Tray # | Color | Tray # |
|--------|---------|-------|---------|
| Purple | 5969214 | Green | 5969254 |
| Yellow | 5969224 | Blue | 5969264 |
| Ivory | 5969234 | Gray | 5969274 |
| Red | 5969244 | Black | 5969284 |

\$119.95/case of 24 (One color per case)

Gloves

Latex Gloves

- Non-powdered and low protein

Small 5910089 Medium 5910090
Large 5910091 X-Large 5910088

\$11.95/box of 100 10 or more **\$9.95/box**



Non-Latex Gloves

- Non-powdered

Small 5910094 Medium 5910092
Large 5910093

\$11.95/box of 100 10 or more **\$9.95/box**



Nitrile Gloves

- Non-powdered

Small 5910095 Medium 5910096
Large 5910097 X-Large 5910098

\$14.95/box of 100 10 or more **\$12.95/box**





Tags for Job Trays

- 100 per box
- 82mm x 25mm

5969100 \$29.95/per box

Tint Pans and Lids

Quart Tint Pan w/Lid

5869532 \$34.95/ea.

9 or More \$29.95/ea.

Tint Pan Only

5869537 \$24.95/ea.

9 or More \$19.95/ea.

Metal Lid Only

5869534 \$19.95/ea.

9 or More \$14.95/ea.



Pint Tint Pan

Tint Pan Only

5869538 \$24.95/ea.

9 or More \$19.95/ea.

Metal Lid Only

5869539 \$19.95/ea.

9 or More \$14.95/ea.



Hot Pot Lifter

5860015 \$29.95/ea.



Tint Thermometer

Easily make sure your tinting temp is just right!

6646739 \$29.95/ea.



Nylon Lens Holder

Lens is held in place with snug tension holders.

Black

5860005 \$25.95/ea.

White

5860006 \$25.95/ea.



Lens Display

- Lucite
- Holds 15 lenses (Not included)

7700000 \$39.95/ea.



9-Pan Tint Unit



Exclusive Design with External Heating Element to Prevent Leaks and Corrosion

- Designed for better heat distribution and more reliable colors
- 1 year limited warranty
- 14.5" wide x 9" high x 22.5" deep
- Features nine standard 1 quart tanks

Lens Pro 9-Pan Tint Unit
with Chemical Starter Pack

Our Best Value!

Includes \$400 in Chemicals

5869913 **\$999.95**

Lens Pro 9-Pan Tint Unit Only

5869912 **\$749.95**

The complete chemical package contains:

| | | |
|-----------------------|-------------|---------|
| Ultra White UV | 8 oz. conc. | 1400908 |
| Ultra White UV Plus | 8 oz. conc. | 1400910 |
| CR-39 Neutralizer | quart | 1402232 |
| Poly Safe Neutralizer | quart | 1402332 |
| Lens Prep | quart | 1403232 |
| 1 Black Lens Holder | | 5860005 |
| 1 White Lens Holder | | 5860006 |
| Black Dye | 4 oz. conc. | 1406004 |
| Grey Dye | 4 oz. conc. | 1407404 |
| Brown Dye | 4 oz. conc. | 1406104 |
| Sun Grey Dye | 4 oz. conc. | 1407604 |
| Sun Brown Dye | 4 oz. conc. | 1406504 |
| Rose Dye | 4 oz. conc. | 1406804 |
| Pink Dye | 4 oz. conc. | 1406904 |
| Blue Dye | 4 oz. conc. | 1406604 |
| Sky Blue Dye | 4 oz. conc. | 1407004 |
| Green Dye | 4 oz. conc. | 1406304 |
| G15 Dye | 4 oz. conc. | 1407104 |
| Yellow Dye | 4 oz. conc. | 1406204 |
| Heat Transfer Fluid | 4 gallons | 1303001 |



Dual Control Tinting Systems

Heat Up Only What You Need, When You Need It!

You need to do a quick tint, you don't need to heat up that big machine. Our dual control tint machines make tinting easy and efficient. This versatile machine is at home in a lab or retail setting. The exclusive design with easily removable basins makes changing your transfer fluid effortless. If you have ever purchased a new tint machine due to leaky basin you will love our removable basin. You won't be replacing this unit any time soon.

- Easy remove basin for quick clean
- Heat all pans or just half
- Super-Fast heating unit
- Save on chemicals cost
- 1 year warranty



6 Pan System

Available in Six Standard 1 Quart Pan or Twelve Pint Pan Configuration

Dual Control 6 Quart Pan
5869917 \$849.95

Dual Control 12 Pint Pan
5869918 \$1,099.95



12 Pan System

NOTE: 20 AMP Breaker is Required for Dual Control Units

Dimensions:
24" wide x 19" high x 13" deep



Gradient Systems

4 Stroke w/Digital Timer
5869996 \$469.95

5 Stroke w/Digital Timer
5869995 \$569.95

17 Inch Pole w/Flange
5869990 \$59.95

12 Inch Pole w/Stand
5869994 \$59.95

MINI Gradient System

4 Stroke No Timer
5869997 \$369.95



Space Saver Tinting Systems

The Exclusive Design with Easily Removable Basins
Makes Changing Your Transfer Fluid Effortless



6 Pan System



3 Pan System

Our customers have spoken, we have heard them loud and clear. You asked for a small tinting system. Space Saver Tint systems are far smaller than traditional tint machines, they fit well on a counter or even a cabinet. If you have ever purchased a new tint machine due to leaky basin you will love our removable basin. You won't be replacing this unit any time soon.

- Easy remove basin for quick clean
- Small and compact size
- Super-Fast heating unit
- Save on chemicals costs
- 1 year warranty

Available in Three Standard 1 Quart Pan
or Six Pint Pan Configuration

Lens Pro Space Saver 3 Pan
5869915 \$629.95

Lens Pro Space Saver Mini 6 Pan
5869916 \$749.95

Dimensions:
11" wide x 15" high x 17.5" deep



Easy to remove basin.

Dynamic Dyes

Dynamic Dyes Are Long Lasting and Stay True to Color

Many of our accounts have told us that our brown and black dyes are the best they have ever used. Dynamic Dyes have the longest color retention, losing only a minimal amount of tint over long periods of time

- Our dyes absorb quickly and evenly
- Available in 4 oz. concentrated liquid or powder formula (Each makes 1 quart.)
- Please dilute with distilled water



Liquid or Powder

\$9.95/ea.

12 or more \$7.95/ea.

36 or more \$5.95/ea.

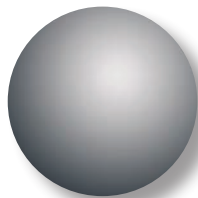

Ultra Black*
1406004
4 oz. Liquid
1406008
Powder



Blue
1406604
4 oz. Liquid
1406608
Powder



Sun Gray
1407604
4 oz. Liquid

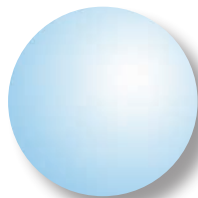

Sky Blue
1407004
4 oz. Liquid
1407008
Powder



Red
1406704
4 oz. Liquid
1406708
Powder



Gray
1407404
4 oz. Liquid
1407408
Powder



Green
1406304
4 oz. Liquid
1406308
Powder

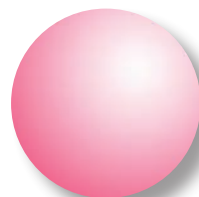

Rose
1406804
4 oz. Liquid
1406808
Powder

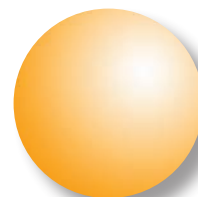

Orange
1407504
4 oz. Liquid
1407508
Powder



Ultra Brown*
1406104
4 oz. Liquid
1406108
Powder



G-15
1407104
4 oz. Liquid
1407108
Powder



Pink
1406904
4 oz. Liquid
1406908
Powder



Yellow
1406204
4 oz. Liquid
1406208
Powder



Sun Brown
1406504
4 oz. Liquid
1406508
Powder



Violet
1407204
4 oz. Liquid
1407208
Powder

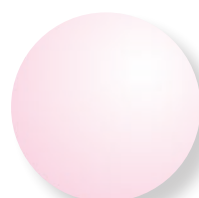

Cruxlight
1406404
4 oz. Liquid
1406408
Powder

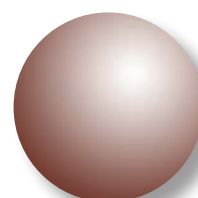

Sahara
1407304
4 oz. Liquid
1407308
Powder

Our Dynamic Ultra Tints* are designed for both tintable polycarbonate and CR-39 lenses



UV Dye Combination

Tint and UV Treat Your Lenses
At the Same Time!

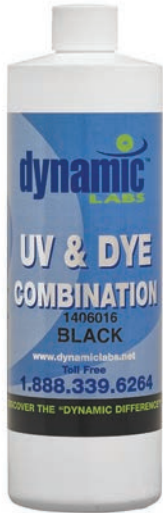

- Black Combo**
1406016 \$19.95/ea.
- Brown Combo**
1406116 \$19.95/ea.
- G-15 Combo**
1407116 \$19.95/ea.
- 6 or more \$17.95/ea.
- 12 or more \$15.95/ea.

Polycarbonate AR Stripper

8 oz. bottle

Do not use metal tweezers with Polycarbonate AR stripper.



1203508 \$64.95/ea.



Plastic AR Stripper Tweezers

3/box

6050735 \$14.95/box



Red Remover

- Removes unwanted "red" hue from lenses
- Extends the life of your tints
- 4 oz. bottle

1407804 \$39.95/ea.

Poly Dyes



Now You Can Tint Polycarbonate As Easy As CR-39

Our chemists have formulated the perfect product to allow you to tint your tintable Polycarbonate lens, to sunglass density. Our Dynamic Poly dyes are specifically designed for maximum absorption in minimal time.

- True color
- 4 oz. concentrated makes 1 quart
- Safe on all lens material

Liquid \$19.95/ea.

12 or more \$17.95/ea.

36 or more \$15.95/ea.

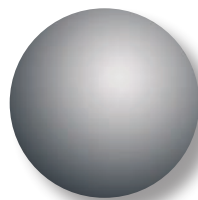

Black Poly
1416004
4 oz. Liquid

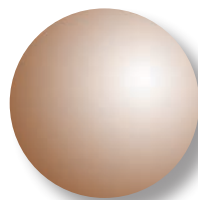

Brown Poly
1416104
4 oz. Liquid

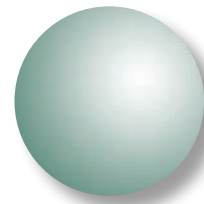

G-15 Poly
1417104
4 oz. Liquid

Neutralizers

Poly Safe Neutralizer

- Completely odorless
- Self-cleaning and a very low evaporation rate
- Won't delaminate, craze, or streak lenses

Gallon

- 1402001 \$72.95/ea.
- 4 or more \$59.95/ea.
- 8 or more \$49.95/ea.

Quart

- 1402332 \$23.95/ea.
- 6 or more \$19.95/ea.
- 12 or more \$15.95/ea.



CR-39 High-Index Neutralizer

- CR-39 Neutralizer for speed
- Poly Safe Neutralizer for versatility



Gallon

- 1402101 \$72.95/ea.
- 4 or more \$49.95/ea.
- 8 or more \$39.95/ea.

Quart

- 1402232 \$23.95/ea.
- 4 or more \$19.95/ea.
- 8 or more \$15.95/ea.

Dynamic Scratch Coat

We Now Have Two Options For Providing Scratch Resistance to Lenses

Works Well With Polycarbonates!



Cold Dip

Scratch coat is applied to your lenses at room temperature in just 10-12 minutes.

Gallon

- 1403601 \$69.95/ea.
- 4 or more \$59.95/ea.
- 8 or more \$49.95/ea.

Hot Dip

Scratch coat is heated in your tint machine and then applied to lenses in only 4 minutes.

Gallon

- 1403101 \$69.95/ea.
- 4 or more \$49.95/ea.
- 8 or more \$39.95/ea.

Quart

- 1403132 \$39.95/ea.
- 4 or more \$29.95/ea.
- 8 or more \$19.95/ea.



Heat Transfer Fluid

Compatible with Any Tint Unit

- Completely odorless
- Low evaporation rate
- Neutralizes spilled dyes
- Corrosion resistant

Gallon

- 1303001 \$72.95/ea.
- 4 or more \$59.95/ea.
- 8 or more \$49.95/ea.

Quart

- 1303832 \$39.95/ea.
- 6 or more \$29.95/ea.
- 12 or more \$19.95/ea.



Heat Transfer Fluid Syphon Pump

To make changing your heat transfer fluid much easier and cleaner!

5860039 \$24.95/ea.



Fresh Scent

4 oz. bottle

Keep Your Tint Machine Smelling Fresh!

Apple

1407904 \$15.95/ea.

Orange

1407914 \$15.95/ea.

Floral

1407924 \$15.95/ea.

3 or more \$12.95/ea.

12 or more \$9.95/ea.



Ultra White and Ultra White Plus

Totally White Formula Eliminates Any Chance of Yellowing the Lens
Treat Up To 400 Lenses Per Bottle!



Won't Yellow
Won't Clump

Ultra White UV™

8 oz. concentrate makes 1 quart.

- Fast-acting UV protection
- No clumping
- Won't Yellow Lenses

1400908 \$68.95/ea.
6 or more \$54.95/ea.
12 or more \$49.95/ea.

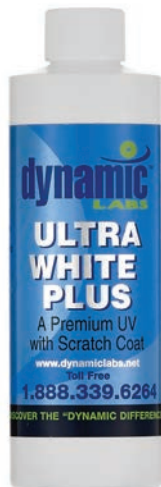

Scratch Protection
In the Same Bottle!

Ultra White UV™ Plus

8 oz. concentrate makes 1 quart.

- Fast-acting UV protection
- No clumping
- No discoloration
- Scratch protection

1400910 \$78.95/ea.
6 or more \$64.95/ea.
12 or more \$54.95/ea.

Dye-B-Gone

- Clean tint pans without scrubbing
- A clean tint pan helps reduce color shifting

Gallon

1402501 \$42.95/ea.
4 or more \$23.95/ea.
8 or more \$17.95/ea.



Ultra UV and Ultra UV Plus

A Combination of UV and Scratch Coat That Increases Scratch Resistance Up to 400%!

- Fast acting, and applied in just 1-4 minutes
- Virtually no yellowing
- Super-concentrated; will treat up to 400 lenses
- Biodegradable and nearly odorless

Ultra UV™

Quart

1401032 \$59.95/ea.
6 or more \$54.95/ea.
12 or more \$49.95/ea.

Fast Acting!



Ultra UV™ Plus Scratch Coat

Quart

1401132 \$69.95/ea.
6 or more \$64.95/ea.
12 or more \$54.95/ea.



Lens Prep

Recommended to reduce spotting, streaking and uneven tinting. Submerge lenses at room temperature before tinting and see incredible improvements in lens tinting.

Quart

1403232 \$19.95/ea.
4 or more \$15.95/ea.
12 or more \$12.95/ea.



Polishing Buffs



a) 6730475



b) 6763506



c) 6763565



d) 6710436



e) 6720450



f) 6740430

Solid Felt Buffs (a)

For first step polishing; made of the finest compressed wool.

| Product Description | Item # | Price |
|---|---------|---------|
| Solid Felt Buff – 4" x 1" | 6730401 | \$19.95 |
| Solid Felt Buff – 4" x 3/4" | 6730475 | \$15.95 |
| Solid Felt Buff – 6" x 1/4" w 7/8" hole | 6730625 | \$15.95 |
| Solid Felt Buff – 6" x 1/4" w 3/4" hole | 6731625 | \$15.95 |

Soft Felt Buff (b)

6-ply with plastic center. A delicate touch and white rouge can remove hairline scratches from lenses before coating. High gloss final lens edge polishing with white rouge.

| Product Description | Item # | Price |
|--------------------------------------|---------|---------|
| Fine 6-Ply Soft Felt Buff 3.5" x .5" | 6763506 | \$19.95 |

Woven Yarn Buff (c)

Light touch for final polish. Produces extra high gloss on lens edges, especially polycarbonate, high index and CR-39. Will not fray or burn lens edges.

| Product Description | Item # | Price |
|---|---------|---------|
| Woven Yarn Buff 3.5" x .75" w 1/4" hole | 6763565 | \$19.95 |

Muslin Buffs (d)

Stiff chemically treated fine-weave muslin. Great for poly and high index edge polishing.

| Product Description | Item # | Price |
|--|---------|---------|
| Combed Muslin w/Solid Center – 4" x 36 Ply | 6710436 | \$12.95 |
| Unbleached Combed Muslin – 4" x 42 Ply | 6710442 | \$9.95 |
| Extra Fine Combed Muslin – 4" x 50 Ply | 6710450 | \$9.95 |
| Yellow Treated Muslin Buff – 4" x 40Ply | 6750440 | \$9.95 |
| Yellow Treated Muslin Buff – 5" x 45Ply | 6750545 | \$9.95 |
| Yellow Treated Muslin Buff – 6" x 50Ply | 6750650 | \$12.95 |

Lint-Free Cotton Buffs (e)

A longer lasting buff that yields hours of smooth work.

| Product Description | Item # | Price |
|-------------------------------------|---------|---------|
| Lint-Free Cotton Buff – 4" x 50 Ply | 6720450 | \$9.95 |
| Lint-Free Cotton Buff – 6" x 60 Ply | 6720660 | \$19.95 |

Cotton Flannel Buffs (f)

Soft cotton flannel produces a high polish when used with rouge. Well stitched with shellac centers.

| Product Description | Item # | Price |
|--|---------|--------|
| Stitched Cotton Flannel Buff – 3" x 30 Ply | 6740330 | \$9.95 |
| Stitched Cotton Flannel Buff – 4" x 30 Ply | 6740430 | \$9.95 |

Polishing Compounds

Comes in a Convenient, Economical, Peel Back Cardboard Tube for Ease of Use and Cleanliness

For best results, do not use more than one type of rouge per buff.



White Rouge

For final gloss polish on polycarbonate and high index, and can be used as a one step polish on CR-39.

6706026 \$7.95/ea.

Green Rouge

Great for 1st step on polycarbonate and high index.

6706021 \$7.95/ea.

Blue Rouge

Use for 1st step on polycarbonate or high index, and can be used on metals as well.

6706022 \$7.95/ea.

Red Rouge

Can be used on glass and precious metals.

6706024 \$7.95/ea.



Vis-a-Vis Marker

Package of 3

Black

7310008 \$6.95/ea.

Blue

7310009 \$6.95/ea.



Expo Dry-Ease Marker

Package of 3

Fine Black

7310018 \$4.95/ea.

Poly Edge Polish

Liquid Glaze Produces a High Gloss Finish



- No special equipment needed
- Available in a 16 oz. bottle

7220108 \$59.95/ea.

Applicators for Poly Edge Polish

100/pk (Not shown)

7220109 \$9.95/ea.

Marking Inks

Quality Higgins waterproof ink recommended for use in lens markers and lensometers.



1 Quart/BLACK

7314016 \$84.95/ea.

1 Ounce/RED

7324001 \$9.95/ea.

1 Ounce/BLACK

7314001 \$9.95/ea.



The Eliminator™ Progressive Marking Ink Remover

Eliminator instantly dissolves and removes any manufacturers' ink markings. Safe on all coatings and materials.

- Safe on polycarbonate and CR-39 lenses
- Leaves no film or oily residue on the lens
- Available in a 16 oz. bottle with convenient spray nozzle and a pen

16 oz. Bottle

1208916 \$49.95/ea.

6 or more \$45.95/ea.

12 or more \$39.95/ea.

The Eliminator™ Marking Remover Pen

1201923 \$24.95/ea.

6 or more \$19.95/ea.



surfacing



The Perfect Polishing Pads for Any Environment

Dynamic Polishing Pads with Adhere™ Backing

Backing features Adhere™ – the industry's best pressure sensitive adhesive that offers the strongest grip, especially in a wet environment, yet still removes easily when the job is finished.

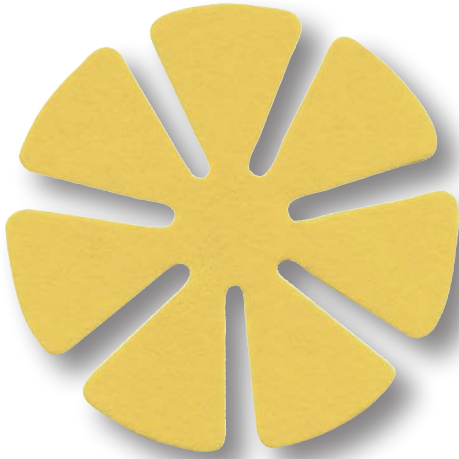

Premium Gold

The gold standard in polish pads. This pad holds more polish and lasts longer.

- 3"
- 7 leaf
- 250/roll

| | |
|------------|--------------|
| 1560800 | \$30.95/roll |
| 6 or more | \$28.95/roll |
| 12 or more | \$25.95/roll |

- 3.25"
- 7 leaf
- 250/roll

| | |
|------------|--------------|
| 1560803 | \$35.95/roll |
| 6 or more | \$33.95/roll |
| 12 or more | \$30.95/roll |



DuraPad White

The "standard" white polish pad that has proven to deliver consistent results for many years.

- 3"
- 7 leaf
- 250/roll

| | |
|------------|--------------|
| 1560600 | \$26.95/roll |
| 6 or more | \$24.95/roll |
| 12 or more | \$22.95/roll |

- 3.25"
- 7 leaf
- 250/roll

| | |
|------------|--------------|
| 1560603 | \$30.95/roll |
| 6 or more | \$28.95/roll |
| 12 or more | \$26.95/roll |

ONE Step System

- One step compensated pads can save you time by taking the place of a 1st and 2nd step pad
- Unique backing will always stick to the lap tool when needed, and remove easily when the job is finished
- 250 pads per roll

CR-39 Choices



P1200 Aluminum Oxide

- 3"
- 7 leaf
- Settings: 14-18 lbs., 0.3-0.4 Bar, 120-150 sec.

1551200 \$40.95/roll
 4 or more \$38.95/roll
 8 or more \$35.95/roll



P1000 Aluminum Oxide

- 3"
- 7 leaf
- Settings: 14-18 lbs., 0.3-0.4 Bar, 120-150 sec.

1551000 \$40.95/roll
 4 or more \$38.95/roll
 8 or more \$35.95/roll



P1200 Aluminum Oxide

- 3"
- 7 leaf
- Settings: 14-15 lbs., 0.3-0.4 Bar, 120-150 sec.

1553120 \$40.95/roll
 4 or more \$38.95/roll
 8 or more \$35.95/roll

Polycarbonate Choices



P500 Aluminum Oxide

- 3"
- 7 leaf
- Settings: 14-18 lbs., 0.3-0.4 Bar, 120-150 sec.

1552500 \$40.95/roll
 4 or more \$38.95/roll
 8 or more \$35.95/roll

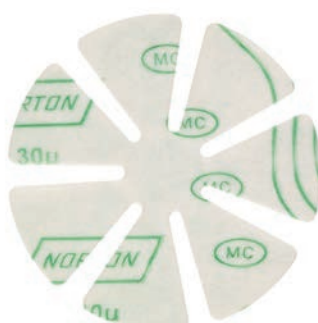

30 Micron Aluminum Oxide

- 3"
- 7 leaf
- Settings: 14-18 lbs., 0.3-0.4 Bar, 120-150 sec.

1552030 \$45.95/roll
 4 or more \$43.95/roll
 8 or more \$41.95/roll



P800 Aluminum Oxide

- 3"
- 7 leaf
- Settings: 14-18 lbs., 0.3-0.4 Bar, 120-150 sec.

1558010 \$37.95/roll
 4 or more \$35.95/roll
 8 or more \$33.95/roll

TWO Step System

- Our 1st fine pad uses a semi-permanent adhesive that sticks to the lap tool during the job but can be removed effortlessly when the job is complete
- Our 2nd step pads use a permanent adhesive that's designed to adhere well to the 1st step pad
- 500 pads per roll

CR-39 Choices

FIRST STEP



P600 Aluminum Oxide

- 3"
- 7 leaf
- Settings: 14-18 lbs., 0.3-0.4 Bar, 50-60 sec.

1536015 \$56.95/roll

4 or more \$53.95/roll

8 or more \$50.95/roll



15 Micron Silicone Carbide

- 3"
- 7 leaf
- Settings: 14-18 lbs., 0.3-0.4 Bar, 50-60 sec.

1536020 \$56.95/roll

4 or more \$53.95/roll

8 or more \$50.95/roll

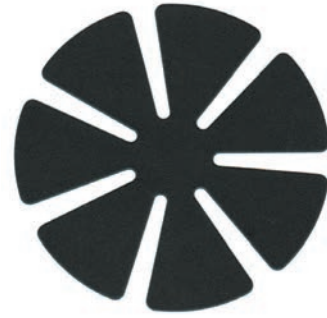

P500 Aluminum Oxide

- 3"
- 7 leaf
- Settings: 14-18 lbs., 0.3-0.4 Bar, 50-60 sec.

1532500 \$56.95/roll

4 or more \$53.95/roll

8 or more \$50.95/roll

SECOND STEP



9 Micron Aluminum Oxide

- 3"
- 7 leaf
- Settings: 14-18 lbs., 0.25-0.3 Bar, 90-120 sec.

1541900 \$57.95/roll

4 or more \$54.95/roll

8 or more \$51.95/roll



3 Micron Aluminum Oxide

- 3"
- 7 leaf
- Settings: 14-18 lbs., 0.25-0.3 Bar, 105-120 sec.

1541300 \$57.95/roll

4 or more \$54.95/roll

8 or more \$51.95/roll



12 Micron Aluminum Oxide

- 3"
- 7 leaf
- Settings: 14-18 lbs., 0.25-0.3 Bar, 90-120 sec.

1542120 \$57.95/roll

4 or more \$54.95/roll

8 or more \$51.95/roll



TWO Step System

- Our 1st fine pad uses a semi-permanent adhesive that sticks to the lap tool during the job but can be removed effortlessly when the job is complete
- Our 2nd step pads use a permanent adhesive that's designed to adhere well to the 1st step pad
- 500 pads per roll

Polycarbonate Choices

FIRST STEP



P280 Silicone Carbide

- 3"
- 7 leaf
- Settings: 14-18 lbs., 0.25-0.3 Bar, 105-120 sec.

1532800 \$56.95/roll

4 or more \$53.95/roll

8 or more \$50.95/roll



P400 Silicone Carbide

- 3"
- 7 leaf
- Settings: 14-18 lbs., 0.3-0.4 Bar, 60-75 sec.

1534000 \$53.95/roll

4 or more \$50.95/roll

8 or more \$47.95/roll

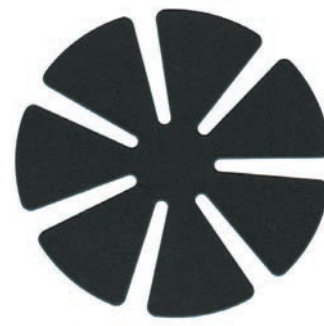

P500 Aluminum Oxide

- 3"
- 7 leaf
- Settings: 14-18 lbs., 0.3-0.4 Bar, 50-60 sec.

1532500 \$56.95/roll

4 or more \$53.95/roll

8 or more \$50.95/roll

SECOND STEP



1000 Aluminum Oxide

- 3"
- 7 leaf
- Settings: 14-18 lbs., 0.3-0.4 Bar, 120-150 sec.

1541000 \$54.95/roll

4 or more \$51.95/roll

8 or more \$48.95/roll



P1200 Aluminum Oxide

- 3"
- 7 leaf
- Settings: 14-18 lbs., 0.3-0.4 Bar, 120-150 sec.

1541200 \$54.95/roll

4 or more \$51.95/roll

8 or more \$48.95/roll



P1200 Aluminum Oxide

- 3"
- 7 leaf
- Settings: 14-18 lbs., 0.3-0.4 Bar, 120-150 sec.

1543120 \$54.95/roll

4 or more \$51.95/roll

8 or more \$48.95/roll

Surface Saver Tape Applicator

Works with Most Size Rolls of Linerless Surface Tape



5871000 \$2,799.95

Utility Knife Handle

Excellent quality knife for all your cutting needs. Comes with single standard blade. Curved blade for use on surface tape is available.



6217101 \$11.95

Straight Blades

- Standard straight pointed
- Pack of 15

6217102 \$19.95



Curved Blades

These blades are great for trimming surface tape or in areas where extra control is needed.

- Reverse curve
- Pack of 5

6217103 \$24.95



3M Surface Tapes

Tapes With Backing For Use With Wax Systems



Surface Saver II #1640

- 50 yards
- Blue with Liner

1521640 \$59.95/roll

6 or more \$54.95/roll

12 or more \$49.95/roll

Surface Saver II #1641

- 50 yards
- Blue with Liner

1521647 \$59.95/roll

6 or more \$54.95/roll

12 or more \$49.95/roll

Surface Saver II #1663

- 78.7402 yards
- Clear Linerless

1521643 \$89.95/roll

6 or more \$79.95/roll

12 or more \$74.95/roll



Surface Tapes

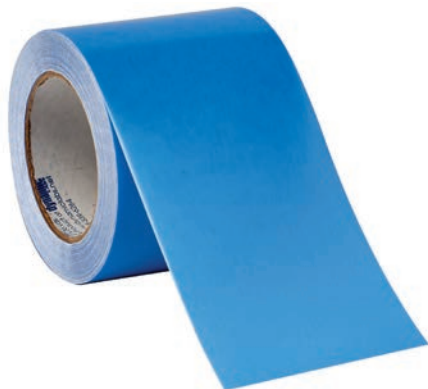

ProtectTape™

Developed Specifically for the Optical Industry!

- Thicker than standard tapes, providing excellent thermal protection
- Provides excellent adhesion

| | | | |
|-----------------------|--------------|------------------------|---------------|
| 4" x 36 Yards w/liner | | 4" x 108 Yards w/liner | |
| 1520904 | \$34.95/roll | 1520108 | \$104.95/roll |
| 12 or more | \$29.95/roll | 12 or more | \$95.95/roll |

Linerless Surface Tape



Armor Surface Tape

- 77 yards
- Medium Tac
- Clear

| | |
|------------|--------------|
| 1520907 | \$74.95/roll |
| 6 or more | \$69.95/roll |
| 12 or more | \$64.95/roll |

Armor Surface Tape

- 77 yards
- Medium Tac
- Clear Blue

| | |
|------------|--------------|
| 1520905 | \$74.95/roll |
| 6 or more | \$69.95/roll |
| 12 or more | \$64.95/roll |



SPARTAN LENS TAPE



Excellent Lens Protection With Secure Hold and Easy Release

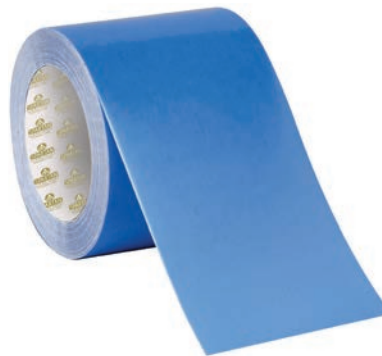

Spartan Lens Tape Medium Tac

- Specifically designed for conventional surfacing
- 4" x 36 yards

| | |
|------------|--------------|
| 1520920 | \$49.95/roll |
| 6 or more | \$44.95/roll |
| 12 or more | \$39.95/roll |

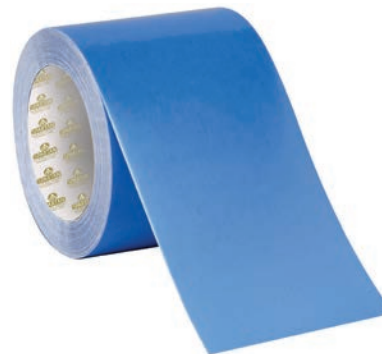

Spartan Lens Tape High Tac

- Specifically designed for digital surfacing
- Formulated for better alloy hold with digital equipment
- 4" x 36 yards

| | |
|------------|--------------|
| 1520925 | \$49.95/roll |
| 6 or more | \$44.95/roll |
| 12 or more | \$39.95/roll |



Laps



Lapmaster Foam Laps

An economical alternative.

1509184 \$385.95/Box (490 per box)

1519662 \$32.95/ ea. Black Adapter



High Diopter Foam Laps

1509185 \$215.95/Box (200 per box)



Semi-Finished Laps

Dimensionally stable, lightweight and rigid laps for a variety of curves

1501002 BASE 2
1501004 BASE 4
1501006 BASE 6
1501008 BASE 8
1501010 BASE 10

\$11.95/ea.

6 or more \$10.95/ea.

12 or more \$9.95/ea.

Ball Cutters



Flute Carbide Cutter

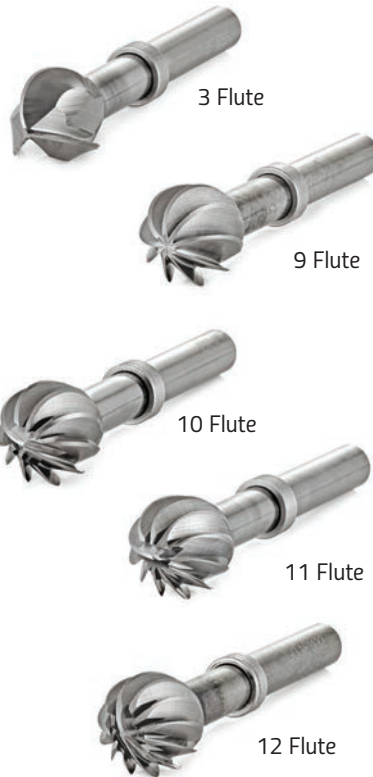

| | | |
|---------|----|----------|
| 7096036 | 3 | \$154.95 |
| 7096033 | 9 | \$119.95 |
| 7096034 | 10 | \$119.95 |
| 7096037 | 11 | \$143.95 |
| 7096035 | 12 | \$143.95 |



Alloy

- Blocking alloy available in three types:
 - Alloy 117° is the most common
 - Alloy 141° is cad free
 - Alloy 158° provides higher temperature blocking for glass lenses
- 3 lb. bar

| | | |
|---------|------|----------------|
| 1510117 | 117° | Call for Price |
| 1510141 | 141° | Call for Price |
| 1510158 | 158° | Call for Price |

Blue Wax

8 lbs. (1 gallon)

1510008 \$142.95/gallon

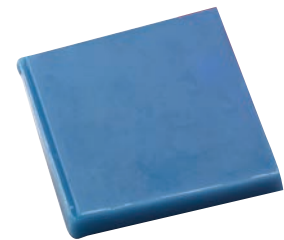

Generator Wheels

| | | |
|---|----------|---------|
| Coburn Wheel for Glass 3.5in | \$365.95 | 7090640 |
| Coburn Wheel Quick Change for Glass 3.5in | \$356.95 | 7090641 |
| Coburn Wheel Brazed for Poly/Plastic 3.5in | \$356.95 | 7090642 |
| Coburn Wheel Quick Change Brazed for Poly/Plastic 3.5in | \$356.95 | 7090643 |
| LOH V-Series Wheel for Glass 2.75in | \$356.95 | 7090644 |

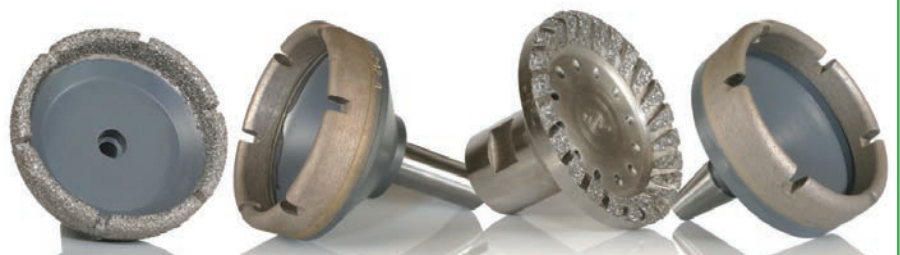

Misc Chemicals

DynaWash™

- Cleans lenses in preparation for coating
- It has a natural clean citrus smell and is biodegradable



| | | |
|-----------|--------|-------------|
| 1003401 | Gallon | \$21.95/ea. |
| 4 or more | | \$18.95/ea. |
| 8 or more | | \$15.95/ea. |

Edger and Generator Coolant

Dynamic Coolant comes with a 100% no foam guarantee. The defoamer is built right into this coolant. This product is long lasting and is concentrated, so that one cup of coolant is all that is necessary to be added to five gallons of water.



| | | |
|-----------|--------|-------------|
| 1304001 | Gallon | \$69.95/ea. |
| 4 or more | | \$49.95/ea. |
| 8 or more | | \$39.95/ea. |

DyNOfoam™ Anti-Foaming Agent

A specialized formulation designed as an anti-foaming agent that can be used for both your generator and edging de-foaming needs.



| | | |
|-----------|--------|-------------|
| 1305101 | Gallon | \$59.95/ea. |
| 4 or more | | \$49.95/ea. |
| 8 or more | | \$39.95/ea. |

| | | |
|-----------|-------|-------------|
| 1305032 | Quart | \$19.95/ea. |
| 4 or more | | \$17.95/ea. |
| 8 or more | | \$15.95/ea. |

Polycarbonate AR Stripper

Safe on CR-39, Hi-Index and Polycarbonate. DO NOT USE ON GLASS. No mixing or pouring. Put lens directly into container with tweezers only.

Do NOT use metal tweezers.

THIS PRODUCT IS NOT BIODEGRADABLE.

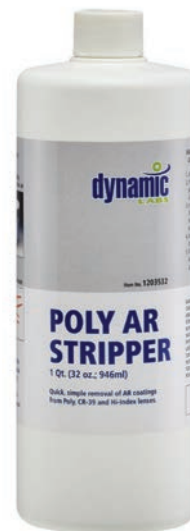

| | | |
|---------|-------|--------------|
| 1203532 | Quart | \$149.95/ea. |
| 1203508 | 8 oz. | \$64.95/ea. |



Plastic AR Stripper Tweezers

- 3 per box

| | |
|---------|-------------|
| 6050735 | \$14.95/box |
|---------|-------------|



Quality Lens Polishes from Dynamic Labs!

Dynamic Lens Polish

Particle size 1.7 microns, Baume of 10°

- Consistent removal rate with its unique particle size profile providing excellent lens clarity
- Easy to clean off both lenses and equipment
- One of the easiest polishes to mix and keep in suspension



1 Gallon

1504201 \$41.95/ea.
4 or more \$36.95/ea.
8 or more \$31.95/ea.

5 Gallon Container

1504205 \$171.95/ea.

DynaPro Powder Lens Polish

Particle size 1.7 microns, Baume of 25°-30°

- A premium polish that combines long slurry, low foaming and easy cleaning features in a convenient powder form
- One 2.9 pound package makes 1 gallon of liquid polish, reducing shipping costs and minimizing storage space



2.9 lb. Package

1504250 \$46.95/ea.
4 or more \$41.95/ea.
8 or more \$36.95/ea.

Dynasty Premium Lens Polish

Particle size 1.7 microns, Baume of 25°-30°

- Utilizes the latest in particle and suspension technology
- Its stock removal rates are capitalized on while surface roughness is reduced
- Designed for standard and digital surfacing



1 Gallon

1504301 \$49.95/ea.
4 or more \$44.95/ea.
8 or more \$39.95/ea.

5 Gallon Container

1504305 \$212.95/ea.

Clarilux Lens Polish

Particle size 1.7 microns, Baume of 30°

- The right choice when the best polish is required at a reasonable price
- Advanced anti-foaming agents
- Designed for standard and digital surfacing



1 Gallon

1504271 \$51.95/ea.
4 or more \$46.95/ea.
8 or more \$41.95/ea.

5 Gallon Container

1504275 \$233.95/ea.

Americal Plus Lens Polish

Ideal for use on polycarbonate lenses.

1 Gallon

1502591 \$50.95/ea.
4 or more \$45.95/ea.
8 or more \$40.95/ea.

5 Gallon Container

1502595 \$250.95/ea.



Lensmax A Lens Polish

- Cerium oxide polish designed specifically to polish glass lenses quickly
- Widely used in central slurry systems

44.0925 lb. Pail

1504455 Call for pricing



Alcohols

Used in cleaning around the lab. Our alcohol is 99% pure and much more effective than less concentrated alcohol you might get locally.

Isopropyl Alcohol



- 1004601 Gallon \$21.95/ea.
- 8 or more \$19.95/ea.
- 16 or more \$17.95/ea.

- 1004832 Quart \$14.95/ea.
- 8 or more \$12.95/ea.

Denatured Alcohol



- 1004301 Gallon \$19.95/ea.
- 8 or more \$19.95/ea.
- 16 or more \$17.95/ea.

- 1004732 Quart \$14.95/ea.
- 8 or more \$12.95/ea.

Gloves



Latex Gloves

- Non-powdered and low protein
- 100/box

Small 5910089 Medium 5910090
Large 5910091 X-Large 5910088
\$11.95/box 10 or more \$9.95/box



Non-Latex Gloves

- Non-powdered
- 100/box

Small 5910094 Medium 5910092
Large 5910093
\$11.95/box 10 or more \$9.95/box



Nitrile Gloves

- Non-powdered
- 100/box

Small 5910095 Medium 5910096
Large 5910097 X-Large 5910098
\$14.95/box 10 or more \$12.95/box

Hydrometer

Reads from 0-26 Baume.
An indispensable tool when
mixing polishing slurries.



6640307 \$89.95/ea.

Spin Coater Parts

Suction Cups

| Rubber | | | Silicon | | |
|--------|-------------|---------|---------|-------------|---------|
| Size | Part number | Price | Size | Part Number | Price |
| 20mm | 1700023 | \$53.53 | 20mm | 1700026 | \$56.75 |
| 35mm | 1700022 | \$41.92 | 35mm | 1700025 | \$58.49 |
| 50mm | 1700024 | \$43.42 | 52mm | 1700027 | \$72.25 |

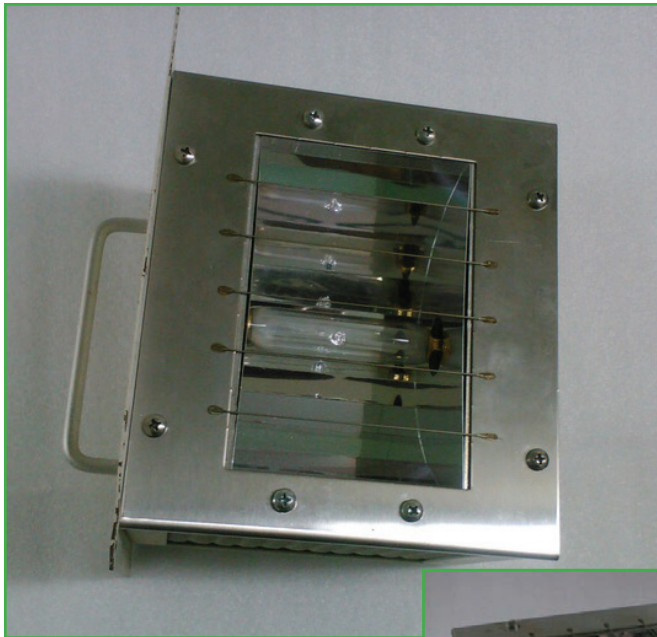
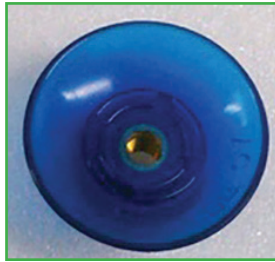
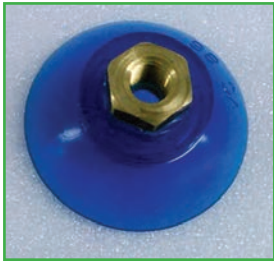

Lighthouse Assembly 1700039 \$620.99

Lighthouse Assembly for Mini 2 coater 1700042 \$620.99

NOTE: By returning the old lighthouse assembly for refurbishment, you will be refunded \$200.00, for an actual price of \$420.99.



Reflectors (set of 3)

1700007 \$53.95

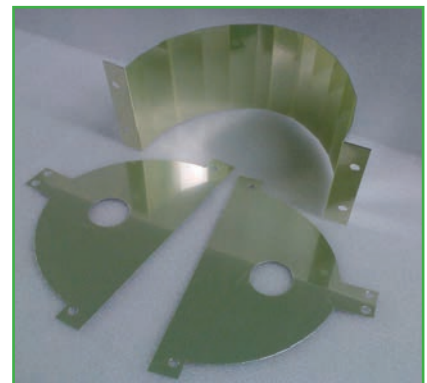

Spin Coater Parts



UV Bulbs

| Bulb | Part number | Price |
|---------------|-------------|----------|
| Simplicity UV | 1700003 | \$337.95 |
| Mini 2 UV | 1700005 | \$337.95 |
| EZ Coat UV | 1700004 | \$337.95 |
| MR-3 UV | 1700006 | \$337.95 |
| Velocity UV | 1700040 | \$375.95 |

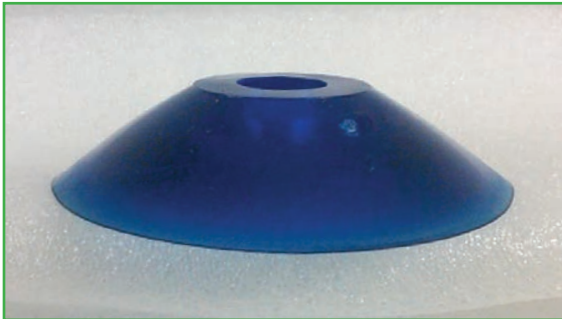

Lens Washing

| Filter | Part number | Price |
|---------------------------------|-------------|----------|
| Haskel Wash Pump | 1700018 | \$937.95 |
| Wash Nozzle - Tip 7SS | 1700028 | \$143.95 |
| Wash Nozzle - Tip 9SS | 1700029 | \$141.95 |
| Wash Nozzle Filter | 1700031 | \$136.95 |
| S/S Coating Nozzle Tube (10 ft) | 1700032 | \$67.95 |
| Blue Air Hose (10 ft) | 1700033 | \$20.95 |
| Wash Nozzle - Tip 9TJ | 1700034 | \$40.95 |
| Wash Nozzle - Tip 17UJ | 1700035 | \$60.95 |
| Wash Nozzle Retaining Nut | 1700036 | \$50.95 |
| Wash Nozzle Stem | 1700037 | \$116.95 |
| Wash Nozzle Strainer | 1700038 | \$78.95 |
| Black Air Hose (10 ft) | 1700019 | \$23.95 |



Coating Pumps

| Pumps | Part number | Price |
|-------------------------------|-------------|----------|
| Gemini CD High Performance | 1700014 | \$389.95 |
| High Performance | 1700016 | \$593.95 |
| Greylor Standard Coating Pump | 1700015 | \$146.95 |

Filters

| Filter | Part number | Price |
|-------------------------|-------------|----------|
| MR3 HEPA Filter | 1700009 | \$443.95 |
| Mini 2 HEPA Filter | 1700010 | \$413.95 |
| EZ Coat HEPA Filter | 1700011 | \$376.95 |
| Simplicity HEPA Filter | 1700008 | \$377.95 |
| Velocity HEPA Filter | 1700041 | \$395.95 |
| Air Pre-Filter | 1700012 | \$29.95 |
| 5 Micron Coating Filter | 1700020 | \$57.95 |
| 20 Micron Wash Filter | 1700021 | \$55.95 |
| Wash Nozzle Filter | 1700031 | \$136.95 |

Hydrophobic & Oleophobic Coatings



Top Coatings For All AR Lenses

Super Hydroseal™ Liquid Coating

A Protective, Water Repellent- Easy to Clean,
Slippery Thin Film Coating for All AR Lenses



Great for Small Batch of Lenses

- Water contact angle of 112° to 118°
- Can be applied as a wipe on method
- A chemically bonded and durable coating for the life of the lenses
- Used by lens labs throughout the U.S.A.
- Available in two bottle sizes; 20 mL and 35 mL

1710002 20mL (Treats 8 pair) \$99.95/ea.
1710003 35mL (Treats 100 pair) \$169.95/ea.

Hydroseal™ Gel Coating

A Cost Effective, Water Repellent-
Easy to Clean, Thin Film Coating
for All AR Lenses



- Water contact angle of 100° to 106°
- Can be applied as a wipe on method
- Durable coating for the life of the lens
- Available in a tube

1710001 5ml (Treats 30 pair) \$19.95/ea.

SureSeal™ Coating

An Oil and Water Repellent
Thin Film Coating
for All AR Lenses



- Water contact angle of 106° to 112°
- Applied through low vacuum chamber (CVD) technology using patented vial package
- Chemically bonded and durable coating for the life of the lens
- Available in one size as a 200 ul vial

1710004 \$12.95/ea.

US Patent Number 7,955,649



Lens Coating

Lens Pro™ Premium UV-Hardcoat

UV Curable Back Side Coating for Spin Coaters

- Safe & effective solvent-free formula
- Compatible with all standard spin coating machines
- Scratch resistant and superior tintability
- Excellent AR adhesion
- Convenient 4 oz. bottle

1700001 \$449.95/ea.

4 or more \$399.95/ea.

8 or more \$379.95/ea.



Conversion Kit

- One 5 micron filter
- One pair of gloves and safety goggles
- Two empty 4 oz. bottles
- Four feet of tubing for coating station
- One gallon size zip bag

1700002 \$72.95/ea.



BEFORE

AFTER

Can You See Me Now?



You can, with our premium fog prevention treatment.
Any lenses. Any eyewear.

FOG
Stopper
AR Lens
Anti-Fog Treatment

More product information on page 32

Index By Product

| | |
|---------------------------------|-----|
| # | |
| 1 Pint Ultrasonic Cleaner | 123 |
| 3M Leap Pads | 137 |
| 3M Anti-Slip Discs | 138 |
| 3M Chip Pads | 143 |
| 3M Surface Tape | 168 |
| 3 Pint Ultrasonic Cleaner | 123 |
| 5-Sided Cutting Broach w/Handle | 112 |

| | |
|--------------------------------|--------------|
| A | |
| Adhesives | 78 |
| Adhesive Dispensing Tips | 78 |
| ACCESSORIES | 33-58 |
| Air-Active Nosepads | 70 |
| Air Frame Warmer | 130 |
| Anodized Aluminum Screwdrivers | 86 |
| Anodized Aluminum Wrenches | 88 |
| Alcohols | 173 |
| Alloy | 170 |
| Anvils | 113 |
| AR Markers | 142 |
| Armor Center Protectors | 143 |
| Armor No-Slip Pads | 138 |
| Armor Oval Felt Backing Pad | 143 |
| Auto Lens Groover | 122 |
| Auto-Polisher | 122 |
| Axis Pliers | 104-105 |

| | |
|-----------------------------|---------|
| B | |
| Ball Cutters | 170 |
| Bench Block | 116 |
| Bench Magnetic Tool Holders | 111 |
| Big Red Tri-Part Pads | 134 |
| Blocking Pads | 132-137 |
| Blocking Pad Dispenser | 137 |
| Blocks | 140-141 |
| Blue Light Readers | 47 |
| Blue Wax | 170 |
| Bracing Bending Pliers | 90-94 |
| Bulbs | 128-129 |
| Bushing Tools | 80 |

| | |
|------------|----|
| C | |
| Cable Kits | 82 |
| Calipers | 89 |

| | |
|------------------------------|--------------|
| Cap Nuts | 76 |
| Cases | 51-55 |
| Cements | 78 |
| Chain/Nose/Snipe Nose Pliers | 100-101 |
| China Markers | 142 |
| CLEANERS & CLOTHS | 17-32 |
| Clip-On Sunglasses | 40-42 |
| Clip-On Mini Brow Light | 34 |
| Cold Dip | 158 |
| Coolant | 171 |

| | |
|---------------------------|---------|
| Cords and Chains | 48-50 |
| Component Kits | 79 |
| Component Organizers | 81 |
| Contact Lens Cases | 34 |
| Cotton Tipped Applicators | 8 |
| Custom Die Stamps | 113 |
| Cutting Pliers | 101-104 |

| | |
|---|----------|
| D | |
| DAS Digital Acuity System | 13 |
| Deburring Tool | 116 |
| Deluxe Digital Self-Calibrating Pupilometer | 9 |
| Deluxe Digital Pupilometer | 120 |
| Deluxe Optician's Tool Kit | 108 |
| Denatured Alcohol | 173 |
| Distometer | 9, 89 |
| Dispensing Trays | 34 |
| Dressing Sticks | 144 |
| Drills | 114 |
| Dual Control Tinting Systems | 126, 154 |
| DuraVision BlueProtect | 63 |
| Dye-B-Gone | 159 |
| DynaGrip Extreme | 139 |
| Dynamic Dyes | 156 |
| DynaWash | 171 |
| DyNOfoam | 171 |

| | |
|--------------------------------|---------|
| E | |
| Eclipse Sun Lens | 64-65 |
| Edging Blocks | 140-141 |
| Edging Pads | 132-137 |
| Edging Pad Styles/Measurements | 133 |
| Edging Color Pens | 142 |
| Edging Wheels | 145-150 |

| | |
|----------------------|-------------|
| Ejector Wrench Set | 88 |
| Eliminator | 162 |
| Ergo Pliers Tool Kit | 110 |
| Eye Charts | 12 |
| Eye Exam Equipment | 13 |
| Eyeglass Cases | 51-55 |
| Eyeglass Holders | 48-50 |
| Eye Patches | 16 |
| Eyewire Screws | 75 |
| EXAM SUPPLIES | 7-16 |

| | |
|--------------------------|----------------|
| F | |
| Files | 112 |
| File Master Set | 112 |
| FINISHING | 131-162 |
| Fit Over Sunwear | 38 |
| Fog Stopper | 32 |
| Foldable Readers | 46 |
| Foreign Body Removal Kit | 15 |
| FRAME PARTS | 67-84 |
| Frame Tags | 81 |
| Frame Warmers | 130 |
| Fresh Scent | 158 |

| | |
|------------------|--------------|
| G | |
| Generator Wheels | 170 |
| Glass Beads | 130 |
| Gloves | 16, 151, 173 |
| Gradient Systems | 126, 154 |

| | |
|-----------------------------|-------|
| H | |
| Hand Drill | 114 |
| Hand Edger | 123 |
| Hard Acetate Temple Tips | 83 |
| Hard Bristle Cleaning Brush | 116 |
| Haven | 38 |
| HD Silicone Nosepads | 68-69 |
| Heat Shield | 115 |
| Heat Shrink Temple Tubing | 82 |
| Heat Transfer Fluid | 158 |
| Heat Transfer Syphon Pump | 158 |
| Hex Nuts | 76 |
| High Speed Twist Drills | 114 |
| High Tension Screw Locker | 78 |
| Hinge Screws | 74-75 |



Index By Product

| | |
|--------------------------|-------------|
| Horizon Blades | 144 |
| Hot Dip | 158 |
| Hot Pot Lifter | 152 |
| Hydrophobic Edging Pads | 134-135,137 |
| Hydrometer | 173 |
| Hypo-Allergenic Nosepads | 71 |

I

| | |
|-------------------------|-----|
| Ishihara's Colour Tests | 13 |
| Isopropyl Alcohol | 173 |

J

| | |
|-----------|-----|
| Job Trays | 151 |
|-----------|-----|

K

| | |
|----------|----|
| Kimwipes | 13 |
|----------|----|

L

| | |
|---|------------------|
| Laminated Paper Bags | 57 |
| Laps | 170 |
| Leatherette Tool Case | 111 |
| LED Lamps | 117 |
| LENSES | 59-66 |
| Lenses | 60-65 |
| Lens Cleaners | 18-21 |
| Lens Cleaner Kits | 22-25 |
| Lens Display | 152 |
| Lens Coatings | 176-177 |
| Lens Grip | 78 |
| Lens Fog Stoppers | 32 |
| Lens Liners | 78 |
| Lens Polishes | 172 |
| Lens Prep | 159 |
| LensPro Edging Pens | 142 |
| LensPro Frame Warmer | 130 |
| LensPro Precision | 135 |
| LensPro Premium UV-Hardcoat | 177 |
| LensPro Scratchless LMU Feeler Tips for Santinelli Nidek | 141 |
| LensPro Tint Systems | 125-127, 153-155 |
| LensPro Traction Control | 138 |
| Lensometer | 121 |
| Lensometer Replacement Parts | 120 |

| | |
|--------------------------------|-----|
| Lindberg UV Curable Adhesive | 78 |
| Linerless Surface Tape | 169 |
| Liquid Dyes | 156 |
| Liquid Liner | 78 |
| Loctite 4851 Flexible Adhesive | 78 |

M

| | |
|--------------------------------|----------------|
| MACHINES | 119-130 |
| Magaccessory | 35 |
| Magnetic Eyeglass Holders | 35 |
| Magnetic Screw Pad | 111 |
| Magnifiers | 117 |
| Mallets | 116 |
| Markers | 142, 161 |
| Marking Inks | 120, 161 |
| Measuring Tools | 89 |
| Megalock Cable Conversion Ends | 82 |
| Midget Screw Extractor | 88 |
| MiniShades | 39 |
| Mirror | 10 |
| Microfiber Cloths | 29-31 |
| Microfiber Full Color Cloths | 30 |
| Microfiber Pouches | 27 |
| Microfiber Pouch Kits | 26 |
| Mydriatic Specs | 10 |

N

| | |
|---------------------------|---------|
| National Optronics Blades | 144 |
| Neutralizers | 158 |
| Non-Slip Frame Tags | 81 |
| Nosepad Adjusting Kit | 87 |
| Nosepads | 68-72 |
| Nosepad Kits | 73 |
| Nosepad Pliers | 98 |
| Nosepad Screws | 76 |
| Nosepad Tools | 72 |
| Nose Pliers | 100-101 |
| Nylon Cords | 49-50 |
| Nylon Lens Holders | 152 |

O

| | |
|----------|----|
| Occluder | 10 |
|----------|----|

| | |
|--------------------------|---|
| Opaque Alcohol Dispenser | 8 |
|--------------------------|---|

P

| | |
|---|----------|
| Parallel Jaw Plier Kit | 106 |
| Parallel Pliers | 96-97 |
| Pattern Blanks | 144 |
| Pen Light | 10 |
| Prescription Aligner | 89 |
| PD Rulers | 9 |
| Pharmaceuticals | 14-15 |
| Photochromic Activator | 124 |
| Pick-Up Screwdrivers | 86 |
| Plastic AR Stripper Tweezers | 157,171 |
| Pliers | 90-105 |
| Polishing Machines | 122 |
| Polishing Pads | 164-167 |
| Polycarbonate AR Stripper | 157, 171 |
| Poly Dyes | 157 |
| Post Mydriatic Specs | 8 |
| Powder Dyes | 156 |
| Precision 9-Piece Screwdriver/Wrench Set | 87 |
| Premium AR Fog Stopper | 32 |
| Prescription Aligner | 9 |
| Press-On D-Segs and Prisms | 58 |
| Private Eyes | 43-45 |
| Progressive Lens Identifier | 124 |
| Progressive Marking Ink Remover | 162 |
| ProGrip 2 Combo Pads | 135 |
| Protectape | 169 |
| Polishing Buffs | 160 |
| Polishing Compounds | 161 |
| Poly Edge Polish | 161 |
| Punches | 113 |
| Pupilometer | 120 |
| Purity Fog Stopper | 32 |
| Purity Lens Cleaner | 18-19 |
| Purity Lens Cleaner Kits | 22-23 |
| Purity Photo-Fun Pouches | 27 |
| Push-Down Dispenser | 8 |

R

| | |
|---------------------------|----|
| Ray-Ban Crimp-On Nosepads | 70 |
|---------------------------|----|



Index By Product

| | |
|---------------------------------------|-------|
| Reach Nuts | 80 |
| Reader Collections | 43-47 |
| Readerest | 35 |
| Red Remover | 157 |
| Retail Bags | 56-57 |
| Rimless Bushings | 77 |
| Rimless Pliers | 94-96 |
| Rimless Screws | 76 |
| Rimless Tools | 80 |
| Rimless Tool Kit | 109 |
| RipClear | 36-37 |
| Rollens Post Mydriatic Roll-Up Shield | 10 |
| Round 20-Space Wheel Organizer | 79 |
| Rouge | 161 |
| Rulers | 9, 89 |

S

| | |
|--------------------------------|-------|
| Salt Pan Frame Warmer | 130 |
| Sanitizing Wipes | 8 |
| Sanitizing Cloths | 8 |
| SecurEdge Pads | 136 |
| SecureEdge Plus Pads | 134 |
| Self Calibrating Pupilometer | 120 |
| Scratch Coat | 158 |
| Scratchless Screwdrivers | 86 |
| Screwdrivers | 86-87 |
| Screwdriver Sets | 87 |
| Screwdriver Replacement Blades | 86 |
| Screw Holding Tool | 116 |
| Screw Holding Tweezer | 87 |
| Screw Extractors | 88 |
| Screw Extractor Set | 88 |
| Screws | 74-76 |
| Screw Kits | 79 |
| Screw Organizers | 81 |
| Scribe Alignment Tool | 116 |
| Seg Height Gauge | 9, 89 |
| Self-Aligning Screws | 74 |
| Self-Tapping Screws | 74 |
| Semi-Rimless Cords | 78 |
| Showroom Mirror | 10 |
| Silicone Conversion Cable Ends | 82 |
| Silver Solder Rods w/Flux | 115 |

| | |
|---------------------------------|----------------|
| Sleeved Screws | 75 |
| Slim Nosepad Tweezers | 87 |
| Slip-On Temple Comfort Cushions | 82 |
| Soldering Equipment | 115 |
| Soldering Station | 115 |
| Soldering Supplies | 115 |
| Space Saver Tinting systems | 127, 155 |
| Spartan Lens Tape | 169 |
| Specialty Pliers | 99-100 |
| Spin Coater Parts | 174-175 |
| Spring Hinge Tool Kit | 116 |
| Spring Loaded Punch | 113 |
| Staking Unit w/Accessories | 113 |
| Standard Optician's Tool Kit | 107 |
| Sterile Alcohol Pads | 8 |
| Stickon Bifocals | 58 |
| Suction Mounted Swivel Vise | 116 |
| Sunglass Lenses | 61-62, 64-65 |
| Sunglass Lens Protector | 36-37 |
| SURFACING | 163-178 |
| Surfacing Pads | 164-167 |
| Surface Saver Tape Applicator | 168 |
| Surface Tapes | 168-169 |
| Swarf Removal Tool | 116 |

T

| | |
|-----------------------------|------------------|
| Tags for Job Trays | 151 |
| Taps | 114 |
| Tap and Drill Assortment | 114 |
| Temple and Cable Kits | 82 |
| Temple Tips | 83 |
| Tinting Dyes | 156-157 |
| Tint Lids | 152 |
| Tint Pans | 152 |
| Tint Thermometer | 152 |
| Tinting Systems | 126-127, 153-155 |
| Tint Units | 125-127 |
| TOOLS | 85-118 |
| Tool Holders | 111 |
| Tool Kits | 106-110 |
| Trial Frame | 11 |
| Trial Lens Set | 11 |
| Trimmable Adhesive Nosepads | 70 |

| | |
|----------|--------|
| Tweezers | 81, 87 |
|----------|--------|

U

| | |
|----------------------------------|---------|
| UltraBlue Pads | 136 |
| Ultrasonic Cleaners | 123 |
| Ultrasonic Solution | 123 |
| Ultra-Thin Poly Nosepads | 72 |
| Ultra UV and Ultra UV Plus | 159 |
| UltraVue AR Coatings | 176 |
| UltraVue Gel Lens Cleaner | 20-21 |
| UltraVue Gel Lens Cleaner Kits | 24-25 |
| UltraVue Hydroseal Coatings | 176 |
| UltraWhite Pads | 136 |
| Ultra White and Ultra White Plus | 159 |
| Universal Measuring Disc | 81 |
| Universal Nut Driver | 116 |
| Utility Knife Blades | 112,168 |
| Utility Knife Handle | 112,168 |
| UV | 159 |
| UV Bulbs | 129 |
| UV Dye Combination | 157 |
| UV Light Meter | 124 |

V

| | |
|-------------|-------|
| Vise | 116 |
| Vision Aids | 117 |
| Visionaries | 40-42 |
| Visor Clips | 34 |

W

| | |
|-------------------------|-----|
| Washers | 76 |
| Water-Cooled Hand Edger | 123 |
| Wax Blocks | 141 |
| Wipes | 13 |
| Wrenches | 88 |
| Wrench Set | 88 |

Z

| | |
|----------------------------|-------|
| Zeiss Custom Plano Program | 60 |
| Zeiss Lens Cleaners | 63 |
| Zeiss Sunglass Lenses | 60-63 |
| Zeiss Pre-Moistened Wipes | 63 |

Are You Missing Out On Potential Sales?



Grow Your Sales With Profitable Accessories

A great way to grow your sales is by offering profitable accessories when dispensing your customers their new eyewear. The time of dispense is often a missed sales opportunity.

Many of our customers enjoy robust accessories sales, while dispensing eyewear. Customers will present a fit over, or a sun clip that compliments the selected frame or offer the perfect chain or a premade reader to the progressive wearer.

Our most successful resellers present these products while dispensing. They sell their accessories, they never dust them.

Ask you knowledgeable Dynamic Labs sales consultant, to help you grow your profitable product line.

See our expanded Accessories Section: pages 33-58

Index By Item Number

| | | | | | | | |
|---------|----------|---------|----------|---------|----------|-------------|----------|
| 1003332 | 123 | 1407004 | 156 | 1536015 | 166 | 1700036 | 175 |
| 1003401 | 171 | 1407104 | 156 | 1536020 | 166 | 1700037 | 175 |
| 1004301 | 173 | 1407116 | 157 | 1541000 | 167 | 1700038 | 175 |
| 1004601 | 173 | 1407204 | 156 | 1541200 | 167 | 1700039 | 174 |
| 1004732 | 173 | 1407304 | 156 | 1541300 | 166 | 1700040 | 129, 175 |
| 1004832 | 173 | 1407404 | 156 | 1541900 | 166 | 1700041 | 175 |
| 1100950 | 78 | 1407504 | 156 | 1542120 | 166 | 1700042 | 174 |
| 1101002 | 78 | 1407604 | 156 | 1543120 | 167 | 1710001 | 176 |
| 1101303 | 78 | 1407804 | 157 | 1551000 | 165 | 1710002 | 176 |
| 1101373 | 78 | 1407904 | 158 | 1551200 | 165 | 1710003 | 176 |
| 1102250 | 78 | 1407914 | 158 | 1552030 | 165 | 1710004 | 176 |
| 1103095 | 78 | 1407924 | 158 | 1552500 | 165 | 2000000 | 18 |
| 1103096 | 78 | 1416004 | 157 | 1553120 | 165 | 2000003 | 18 |
| 1103097 | 78 | 1416104 | 157 | 1558010 | 165 | 2000005 | 18 |
| 1104851 | 78 | 1417104 | 157 | 1560600 | 164 | 2000091 | 22 |
| 1201923 | 162 | 1501002 | 170 | 1560603 | 164 | 2000092 | 22 |
| 1203508 | 157, 171 | 1501004 | 170 | 1560800 | 164 | 200009B | 22 |
| 1203532 | 171 | 1501006 | 170 | 1560803 | 164 | 200009P | 22 |
| 1208916 | 162 | 1501008 | 170 | 1700001 | 177 | 200009UV1 | 24 |
| 1303001 | 158 | 1501010 | 170 | 1700002 | 177 | 200009UV2 | 24 |
| 1303832 | 158 | 1502591 | 172 | 1700003 | 129, 175 | 200009UVB | 24 |
| 1304001 | 171 | 1502595 | 172 | 1700004 | 129, 175 | 200009UVP | 24 |
| 1305032 | 171 | 1504201 | 172 | 1700005 | 129, 175 | 2000091BR | 23 |
| 1305101 | 171 | 1504205 | 172 | 1700006 | 129, 175 | 2000091UVBR | 25 |
| 1400908 | 159 | 1504250 | 172 | 1700007 | 174 | 2000092BR | 23 |
| 1400910 | 159 | 1504271 | 172 | 1700008 | 175 | 2000092UVBR | 25 |
| 1401032 | 159 | 1504301 | 172 | 1700009 | 175 | 2017200 | 19 |
| 1401132 | 159 | 1504305 | 172 | 1700010 | 175 | 2017210 | 18 |
| 1402001 | 158 | 1504455 | 172 | 1700011 | 175 | 2024300 | 32 |
| 1402101 | 158 | 1507275 | 172 | 1700012 | 175 | 2024301 | 32 |
| 1402232 | 158 | 1509184 | 170 | 1700014 | 175 | 2024324 | 32 |
| 1402332 | 158 | 1509185 | 170 | 1700015 | 175 | 2027200 | 19 |
| 1402501 | 159 | 1510008 | 170 | 1700016 | 175 | 2027210 | 18 |
| 1403101 | 158 | 1510117 | 170 | 1700018 | 175 | 2027210-B | 18 |
| 1403132 | 158 | 1510141 | 170 | 1700019 | 175 | 2027210-P | 18 |
| 1403232 | 159 | 1510158 | 170 | 1700020 | 175 | 2047200 | 19 |
| 1403601 | 158 | 1519662 | 170 | 1700021 | 175 | 2047210 | 18 |
| 1406004 | 156 | 1520108 | 169 | 1700022 | 174 | 2087200 | 19 |
| 1406016 | 157 | 1520904 | 169 | 1700023 | 174 | 2087210 | 18 |
| 1406104 | 156 | 1520905 | 169 | 1700024 | 174 | 2099200 | 19 |
| 1406116 | 157 | 1520907 | 169 | 1700025 | 174 | 2611800 | 21 |
| 1406204 | 156 | 1520920 | 169 | 1700026 | 174 | 2611810 | 20 |
| 1406304 | 156 | 1520925 | 169 | 1700027 | 174 | 2621800 | 21 |
| 1406404 | 156 | 1521640 | 168 | 1700028 | 175 | 2621810 | 20 |
| 1406504 | 156 | 1521643 | 168 | 1700029 | 175 | 2621810-B | 20 |
| 1406604 | 156 | 1521647 | 168 | 1700031 | 175 | 2621810-P | 20 |
| 1406704 | 156 | 1532500 | 166, 167 | 1700032 | 175 | 2641810 | 20 |
| 1406804 | 156 | 1532800 | 167 | 1700033 | 175 | 2681810 | 20 |
| 1406904 | 156 | 1534000 | 167 | 1700034 | 175 | 2912113 | 28 |
| | | | | 1700035 | 175 | 2942001 | 28 |
| | | | | | | 2942002 | 28 |
| | | | | | | 2942003 | 28 |
| | | | | | | 2942004 | 28 |
| | | | | | | 2942005 | 28 |
| | | | | | | 2942006 | 28 |
| | | | | | | 2942007 | 28 |
| | | | | | | 2942008 | 28 |



Index By Item Number

| | | | | | | | |
|--------------|----|--------------|----|--------------|----|-----------------|----|
| 2942009..... | 28 | 2943101..... | 31 | 2952304..... | 29 | 2996623..... | 30 |
| 2942010..... | 28 | 2943102..... | 31 | 2952305..... | 29 | 2996626..... | 30 |
| 2942012..... | 28 | 2943103..... | 31 | 2952306..... | 29 | 2996627..... | 30 |
| 2942013..... | 28 | 2943104..... | 31 | 2952307..... | 29 | 2996628..... | 30 |
| 2942014..... | 28 | 2943106..... | 31 | 2952308..... | 29 | 2996629..... | 30 |
| 2942101..... | 28 | 2943107..... | 31 | 2952309..... | 29 | 2996631..... | 30 |
| 2942102..... | 28 | 2943301..... | 31 | 2952310..... | 29 | 2996632..... | 30 |
| 2942103..... | 28 | 2943302..... | 31 | 2952312..... | 29 | 2996633..... | 30 |
| 2942104..... | 28 | 2943303..... | 31 | 2952313..... | 29 | 2996634..... | 30 |
| 2942105..... | 28 | 2943304..... | 31 | 2952314..... | 29 | 2996641..... | 30 |
| 2942106..... | 28 | 2943306..... | 31 | 2952401..... | 29 | 2996642..... | 30 |
| 2942107..... | 28 | 2943307..... | 31 | 2952402..... | 29 | 2996643..... | 30 |
| 2942108..... | 28 | 2943401..... | 31 | 2952403..... | 29 | 2996644..... | 30 |
| 2942109..... | 28 | 2943402..... | 31 | 2952404..... | 29 | 2A000091..... | 26 |
| 2942110..... | 28 | 2943403..... | 31 | 2952405..... | 29 | 2A000092..... | 26 |
| 2942112..... | 28 | 2943404..... | 31 | 2952406..... | 29 | 2A00009UV1..... | 26 |
| 2942114..... | 28 | 2943406..... | 31 | 2952407..... | 29 | 2A00009UV2..... | 26 |
| 2942301..... | 28 | 2943407..... | 31 | 2952408..... | 29 | 2A92001..... | 27 |
| 2942302..... | 28 | 2945100..... | 16 | 2952409..... | 29 | 2A92002..... | 27 |
| 2942303..... | 28 | 2945160..... | 16 | 2952410..... | 29 | 2A92003..... | 27 |
| 2942304..... | 28 | 2952001..... | 29 | 2952412..... | 29 | 2A92004..... | 27 |
| 2942305..... | 28 | 2952002..... | 29 | 2952413..... | 29 | 2A92005..... | 27 |
| 2942306..... | 28 | 2952003..... | 29 | 2952414..... | 29 | 2A92006..... | 27 |
| 2942307..... | 28 | 2952004..... | 29 | 2954100..... | 16 | 2A92008..... | 27 |
| 2942308..... | 28 | 2952005..... | 29 | 2954115..... | 16 | 2A92009..... | 27 |
| 2942309..... | 28 | 2952006..... | 29 | 2961030..... | 63 | 2A92011..... | 27 |
| 2942310..... | 28 | 2952007..... | 29 | 2962222..... | 63 | 2A92012..... | 27 |
| 2942312..... | 28 | 2952008..... | 29 | 2990001..... | 56 | 2A92013..... | 27 |
| 2942313..... | 28 | 2952009..... | 29 | 2990002..... | 56 | 2A92014..... | 27 |
| 2942314..... | 28 | 2952010..... | 29 | 2991000..... | 56 | 2A92015..... | 27 |
| 2942401..... | 28 | 2952012..... | 29 | 2991001..... | 57 | 2A92016..... | 27 |
| 2942402..... | 28 | 2952013..... | 29 | 2991002..... | 57 | 2A92018..... | 27 |
| 2942403..... | 28 | 2952014..... | 29 | 2991003..... | 57 | 2A92019..... | 27 |
| 2942404..... | 28 | 2952101..... | 29 | 2991004..... | 57 | 2A92020..... | 27 |
| 2942405..... | 28 | 2952102..... | 29 | 2991005..... | 56 | 2A92021..... | 27 |
| 2942406..... | 28 | 2952103..... | 29 | 2991006..... | 56 | 2A92022..... | 27 |
| 2942407..... | 28 | 2952104..... | 29 | 2992000..... | 56 | 2A92023..... | 27 |
| 2942408..... | 28 | 2952105..... | 29 | 2992001..... | 57 | 2A92024..... | 27 |
| 2942409..... | 28 | 2952106..... | 29 | 2992002..... | 57 | 2A92025..... | 27 |
| 2942410..... | 28 | 2952107..... | 29 | 2992003..... | 57 | 3000071..... | 55 |
| 2942412..... | 28 | 2952108..... | 29 | 2992004..... | 57 | 3002021..... | 53 |
| 2942413..... | 28 | 2952109..... | 29 | 2992005..... | 56 | 3002023..... | 54 |
| 2942414..... | 28 | 2952110..... | 29 | 2992006..... | 56 | 3002031..... | 53 |
| 2943001..... | 31 | 2952112..... | 29 | 2996613..... | 30 | 3002039..... | 54 |
| 2943002..... | 31 | 2952113..... | 29 | 2996615..... | 30 | 3002079..... | 54 |
| 2943003..... | 31 | 2952114..... | 29 | 2996616..... | 30 | 3002083..... | 54 |
| 2943004..... | 31 | 2952301..... | 29 | 2996617..... | 30 | 3002089..... | 54 |
| 2943006..... | 31 | 2952302..... | 29 | 2996618..... | 30 | 3002101..... | 54 |
| 2943007..... | 31 | 2952303..... | 29 | 2996619..... | 30 | 3002189..... | 54 |



Index By Item Number

| | | | | | | | |
|--------------|----|--------------|----|--------------|----|-----------------|----|
| 3002190..... | 54 | 3101000..... | 48 | 3290015..... | 36 | 3301815..... | 48 |
| 3010021..... | 51 | 3101100..... | 49 | 3290016..... | 36 | 3301819..... | 48 |
| 3010023..... | 51 | 3101203..... | 50 | 3290017..... | 36 | 3301841..... | 48 |
| 3010031..... | 51 | 3101204..... | 50 | 3290018..... | 36 | 3301899..... | 48 |
| 3010033..... | 51 | 3101225..... | 50 | 3290019..... | 36 | 3302000..... | 48 |
| 3010101..... | 51 | 3101335..... | 50 | 3290020..... | 36 | 3302032..... | 35 |
| 3010103..... | 51 | 3101339..... | 50 | 3290021..... | 36 | 3302081..... | 35 |
| 3011003..... | 52 | 3101403..... | 50 | 3290022..... | 36 | 3302082..... | 35 |
| 3011019..... | 52 | 3101409..... | 50 | 3290023..... | 36 | 3302083..... | 35 |
| 3011021..... | 51 | 3101435..... | 50 | 3290024..... | 36 | 3302085..... | 35 |
| 3011023..... | 51 | 3101679..... | 48 | 3290025..... | 36 | 3302086..... | 35 |
| 3011031..... | 51 | 3101711..... | 48 | 3290026..... | 36 | 3302087..... | 35 |
| 3011033..... | 51 | 3101715..... | 48 | 3290027..... | 36 | 3302088..... | 35 |
| 3011035..... | 52 | 3101719..... | 48 | 3290028..... | 36 | 3401207..... | 49 |
| 3011073..... | 52 | 3102000..... | 50 | 3290029..... | 36 | 3401209..... | 49 |
| 3011101..... | 51 | 3102203..... | 49 | 3290030..... | 36 | 3422101XXX..... | 34 |
| 3011103..... | 51 | 3102204..... | 49 | 3290031..... | 36 | 22106XXX..... | 46 |
| 3012021..... | 51 | 3102207..... | 49 | 3290032..... | 36 | 3422109XXX..... | 46 |
| 3012023..... | 51 | 3102208..... | 49 | 3290033..... | 36 | 34500000..... | 47 |
| 3012031..... | 51 | 3102209..... | 49 | 3290034..... | 36 | 34500XXX..... | 47 |
| 3012033..... | 51 | 3102210..... | 49 | 3290035..... | 36 | 34510XXX..... | 47 |
| 3012086..... | 52 | 3102267..... | 49 | 3290036..... | 36 | 34520XXX..... | 47 |
| 3012101..... | 51 | 3103000..... | 50 | 3290037..... | 36 | 3452161..... | 43 |
| 3012103..... | 51 | 3104000..... | 50 | 3290038..... | 36 | 345217XXX..... | 45 |
| 3012116..... | 52 | 3105000..... | 50 | 3290039..... | 36 | 345218XXX..... | 44 |
| 3012386..... | 52 | 3106000..... | 50 | 3290040..... | 36 | 345219XXX..... | 44 |
| 3012396..... | 52 | 3107000..... | 49 | 3290041..... | 36 | 345228XXX..... | 44 |
| 3013021..... | 52 | 3117000..... | 50 | 3290042..... | 36 | 345229XXX..... | 44 |
| 3013031..... | 52 | 3117707..... | 50 | 3290043..... | 36 | 345230XXX..... | 44 |
| 3013131..... | 52 | 3117708..... | 50 | 3290044..... | 36 | 345231XXX..... | 45 |
| 3013231..... | 52 | 3117709..... | 50 | 3290045..... | 36 | 345232XXX..... | 45 |
| 3014021..... | 52 | 3117716..... | 50 | 3290046..... | 36 | 345233XXX..... | 45 |
| 3014031..... | 52 | 3201901..... | 48 | 3290047..... | 36 | 345234XXX..... | 45 |
| 3015021..... | 54 | 3202001..... | 48 | 3290048..... | 36 | 345235XXX..... | 45 |
| 3015031..... | 54 | 3202102..... | 48 | 3290049..... | 36 | 345236XXX..... | 44 |
| 3015069..... | 54 | 3280050..... | 36 | 3290051..... | 36 | 345237XXX..... | 44 |
| 3015070..... | 54 | 3290001..... | 36 | 3290052..... | 36 | 345238XXX..... | 44 |
| 3016031..... | 54 | 3290002..... | 36 | 3290053..... | 36 | 34530XXX..... | 47 |
| 3016066..... | 54 | 3290003..... | 36 | 3290054..... | 36 | 34540XXX..... | 47 |
| 3016067..... | 54 | 3290004..... | 36 | 3290055..... | 36 | 3455099..... | 38 |
| 3023021..... | 53 | 3290005..... | 36 | 3290056..... | 36 | 3455100..... | 38 |
| 3023031..... | 53 | 3290006..... | 36 | 3290057..... | 36 | 3455101..... | 38 |
| 3070001..... | 55 | 3290007..... | 36 | 3290058..... | 36 | 3455103..... | 38 |
| 3075071..... | 52 | 3290008..... | 36 | 3290059..... | 36 | 3455200..... | 38 |
| 3075078..... | 55 | 3290010..... | 36 | 3290060..... | 36 | 3455201..... | 38 |
| 3075081..... | 52 | 3290011..... | 36 | 3290061..... | 36 | 3455300..... | 38 |
| 3075088..... | 55 | 3290012..... | 36 | 3291000..... | 37 | 3455400..... | 38 |
| 3075091..... | 52 | 3290013..... | 36 | 3292000..... | 37 | 3455500..... | 38 |
| 3075099..... | 55 | 3290014..... | 36 | 3301800..... | 48 | 3455600..... | 38 |

EXAM SUPPLIES

CLEANERS & CLOTHS

ACCESSORIES

SUN LENSES

FRAME PARTS

TOOLS

MACHINES

FINISHING

SURFACING

INDEX



Index By Item Number

| | | | |
|--------------------|-------------------|----------------|----------------|
| 36000036.....40 | 3910001.....13 | 4010411.....76 | 4015113.....74 |
| 3601XXXXXXX.....41 | 3910002.....12 | 4010415.....76 | 4015115.....74 |
| 3602XXXXXXX.....41 | 3910003.....12 | 4010416.....76 | 4015432.....74 |
| 3603XXXXXXX.....41 | 3910004.....12 | 4011092.....76 | 4015435.....74 |
| 3604XXXXXXX.....41 | 3910005.....12 | 4011551.....76 | 4015642.....74 |
| 3605XXXXXXX.....41 | 3910006.....12 | 4012093.....76 | 4015645.....74 |
| 3606XXXXXXX.....41 | 3910007.....12 | 4012112.....74 | 4016113.....74 |
| 3607XXXXXXX.....41 | 3910008.....11 | 4012115.....74 | 4016583.....75 |
| 3609XXXXXXX.....41 | 3910009.....11 | 4012116.....76 | 4017113.....74 |
| 3610XXXXXXX.....41 | 3910061.....13 | 4012321.....76 | 4017903.....75 |
| 3611XXXXXXX.....41 | 3910063.....16 | 4012352.....74 | 4110411.....76 |
| 3612XXXXXXX.....41 | 3910064.....16 | 4012355.....74 | 4110415.....76 |
| 3613XXXXXXX.....41 | 3910065.....16 | 4012441.....75 | 4110416.....76 |
| 3614XXXXXXX.....41 | 3910066.....13 | 4012642.....74 | 4111092.....76 |
| 3615XXXXXXX.....41 | 3910066-24.....13 | 4012645.....74 | 4112093.....76 |
| 3617XXXXXXX.....41 | 3921250.....10 | 4013093.....76 | 4112112.....74 |
| 3618XXXXXXX.....41 | 3922250.....10 | 4013112.....74 | 4112116.....76 |
| 3619XXXXXXX.....41 | 3940363.....117 | 4013113.....74 | 4112352.....74 |
| 3620XXXXXXX.....41 | 3940364.....117 | 4013115.....74 | 4112441.....75 |
| 3675000.....34 | 3940365.....117 | 4013351.....75 | 4112642.....74 |
| 3675001.....34 | 3949001.....34 | 4013432.....74 | 4113092.....76 |
| 3675002.....34 | 3999001.....58 | 4013435.....74 | 4113112.....74 |
| 3675003.....34 | 3999002.....58 | 4013642.....74 | 4113113.....74 |
| 3675004.....34 | 3999003.....58 | 4013645.....74 | 4113351.....75 |
| 3675005.....34 | 3999004.....58 | 4014103.....76 | 4113432.....74 |
| 3675006.....34 | 3999005.....58 | 4014112.....74 | 4114103.....76 |
| 3675007.....34 | 3999006.....58 | 4014113.....74 | 4114112.....74 |
| 3702XXXXXXX.....41 | 3999007.....58 | 4014115.....74 | 4114113.....74 |
| 3703XXXXXXX.....41 | 3999008.....58 | 4014116.....76 | 4114115.....74 |
| 3704XXXXXXX.....41 | 3999009.....58 | 4014302.....75 | 4114116.....76 |
| 3705XXXXXXX.....41 | 3999010.....58 | 4014381.....75 | 4114302.....75 |
| 3706XXXXXXX.....41 | 3999012.....58 | 4014385.....75 | 4114381.....75 |
| 3707XXXXXXX.....41 | 3999015.....58 | 4014386.....75 | 4114385.....75 |
| 3711XXXXXXX.....41 | 3999020.....58 | 4014404.....75 | 4114386.....75 |
| 38130103.....39 | 3999025.....58 | 4014432.....74 | 4114432.....74 |
| 38130203.....39 | 3999030.....58 | 4014434.....75 | 4114441.....75 |
| 38130603.....39 | 3999035.....58 | 4014435.....74 | 4114442.....75 |
| 38130701.....39 | 3999040.....58 | 4014441.....75 | 4114445.....75 |
| 38130703.....39 | 3999410.....58 | 4014442.....75 | 4114522.....75 |
| 38130337.....39 | 3999415.....58 | 4014445.....75 | 4114642.....74 |
| 38130437.....39 | 3999420.....58 | 4014446.....75 | 4115112.....74 |
| 38130537.....39 | 3999425.....58 | 4014502.....75 | 4115113.....74 |
| 38130837.....39 | 3999430.....58 | 4014505.....75 | 4115432.....74 |
| 38130937.....39 | 3999450.....58 | 4014522.....75 | 4116113.....74 |
| 3908025.....10 | 3999460.....58 | 4014535.....75 | 4117113.....74 |
| 3908125.....10 | 3999616.....58 | 4014622.....75 | 4117602.....75 |
| 3909101.....10 | 3999617.....58 | 4014642.....74 | 4212112.....74 |
| 3909102.....10 | 3999618.....58 | 4014645.....74 | 4212113.....74 |
| 3910000.....12 | 3999619.....58 | 4015112.....74 | 4212116.....76 |



Index By Item Number

| | | | |
|---------------------|---------------------|-----------------|----------------|
| 4212352.....74 | 4508027.....77, 109 | 4814204.....83 | 5013115.....69 |
| 4212441.....75 | 4508027-S.....77 | 4814601.....82 | 5013211.....69 |
| 4212642.....74 | 4508028.....77, 109 | 4814602.....82 | 5013212.....69 |
| 4213112.....74 | 4508028-S.....77 | 4814603.....82 | 5013215.....69 |
| 4213113.....74 | 4508029.....77, 109 | 4814605.....82 | 5015111.....69 |
| 4213351.....75 | 4508029-S.....77 | 4814607.....82 | 5015112.....69 |
| 4213432.....74 | 4508030.....77 | 4814701.....82 | 5015115.....69 |
| 4214103.....76 | 4508030-S.....77 | 4814702.....82 | 5015131.....71 |
| 4214112.....74 | 4508031.....77 | 4814703.....82 | 5015132.....71 |
| 4214113.....74 | 4508038.....77, 109 | 4814705.....82 | 5015135.....71 |
| 4214115.....74 | 4508039.....77 | 4814706.....82 | 5015211.....69 |
| 4214116.....76 | 4512101.....76 | 4814707.....82 | 5015212.....69 |
| 4214302.....75 | 4512102.....76 | 4814708.....82 | 5015215.....69 |
| 4214381.....75 | 4512104.....76 | 4814709.....82 | 5015231.....71 |
| 4214386.....75 | 4512205.....77 | 4815201.....83 | 5015232.....71 |
| 4214432.....74 | 4514101.....76 | 4815202.....83 | 5015235.....71 |
| 4214441.....75 | 4514102.....76 | 4815203.....83 | 5015411.....69 |
| 4214442.....75 | 4514103.....76 | 4815204.....83 | 5015412.....69 |
| 4214522.....75 | 4514205.....77 | 4815301.....83 | 5015415.....69 |
| 4214642.....74 | 4515104.....76 | 4815302.....83 | 5017111.....69 |
| 4215112.....74 | 4600001.....79 | 4815303.....83 | 5017112.....69 |
| 4215113.....74 | 4600002.....79 | 4815304.....83 | 5017115.....69 |
| 4215432.....74 | 4600003.....79 | 4816201.....83 | 5017131.....71 |
| 4311221.....76 | 4600004.....79 | 4816202.....83 | 5017132.....71 |
| 4311222.....76 | 4600005.....79 | 4816203.....83 | 5017135.....71 |
| 4312221.....76 | 4800901.....82 | 4816204.....83 | 5017211.....69 |
| 4312222.....76 | 4801901.....82 | 4816301.....83 | 5017212.....69 |
| 4312223.....76 | 4802901.....82 | 4816302.....83 | 5017231.....71 |
| 4313251.....76 | 4803901.....82 | 4816303.....83 | 5017232.....71 |
| 4313252.....76 | 4810001.....82 | 4816304.....83 | 5017235.....71 |
| 4314251.....76 | 4810003.....82 | 4819201.....83 | 5017411.....69 |
| 4314252.....76 | 4811101.....83 | 4819202.....83 | 5017412.....69 |
| 4314253.....76 | 4811102.....83 | 4819203.....83 | 5017415.....69 |
| 4411221.....76 | 4811103.....83 | 4819204.....83 | 5019111.....69 |
| 4411222.....76 | 4811104.....83 | 4821801.....82 | 5019112.....69 |
| 4412221.....76 | 4812101.....83 | 4831801.....82 | 5019115.....69 |
| 4412222.....76 | 4812102.....83 | 4831803.....82 | 5019131.....71 |
| 4412251.....80 | 4812103.....83 | 4847801.....82 | 5019132.....71 |
| 4412252.....80 | 4812104.....83 | 4847803.....82 | 5019135.....71 |
| 4413251.....76 | 4812800.....82 | 50121125.....70 | 5019211.....69 |
| 4413252.....76 | 4812803.....82 | 5012115.....70 | 5019212.....69 |
| 4414221.....76 | 4813101.....83 | 50121325.....70 | 5019215.....69 |
| 4414222.....76 | 4813102.....83 | 5012135.....70 | 5019231.....71 |
| 4414223.....76 | 4813103.....83 | 50121525.....70 | 5019232.....71 |
| 4414251.....80 | 4813104.....83 | 5012155.....70 | 5019235.....71 |
| 4414252.....80 | 4813403.....83 | 50122515.....70 | 5111111.....68 |
| 4414254.....76 | 4814201.....83 | 5012515.....70 | 5111112.....68 |
| 4508025.....77, 109 | 4814202.....83 | 5013111.....69 | 5111115.....68 |
| 4508026.....77 | 4814203.....83 | 5013112.....69 | 5111212.....68 |

Index By Item Number

| | | | |
|----------------|----------------|-----------------|----------------------|
| 5111215.....68 | 5209212.....68 | 5613232.....71 | 5860005.....152 |
| 5112111.....68 | 5209215.....68 | 5613235.....71 | 5860006.....152 |
| 5112311.....69 | 5209221.....72 | 5614610.....70 | 5860015.....152 |
| 5112312.....69 | 5209222.....72 | 5614612.....70 | 5860039.....158 |
| 5112315.....69 | 5209225.....72 | 5615111.....68 | 5860400.....124 |
| 5113111.....68 | 5209231.....71 | 5615112.....68 | 5869532.....152 |
| 5113112.....68 | 5209232.....71 | 5615115.....68 | 5869534.....152 |
| 5113115.....68 | 5209235.....71 | 5615131.....71 | 5869537.....152 |
| 5113121.....72 | 5209311.....69 | 5615132.....71 | 5869538.....152 |
| 5113122.....72 | 5209312.....69 | 5615135.....71 | 5869539.....152 |
| 5113125.....72 | 5209315.....69 | 5615211.....68 | 5869912.....125, 153 |
| 5113131.....71 | 5209411.....69 | 5615212.....68 | 5869913.....125, 153 |
| 5113132.....71 | 5209412.....69 | 5615215.....68 | 5869915.....127, 155 |
| 5113135.....71 | 5209415.....69 | 5615231.....71 | 5869916.....127, 155 |
| 5113211.....68 | 5211111.....68 | 5615232.....71 | 5869917.....126, 154 |
| 5113212.....68 | 5211112.....68 | 5615235.....71 | 5869918.....126, 154 |
| 5113215.....68 | 5211115.....68 | 5616610.....70 | 5869990.....126, 154 |
| 5113221.....72 | 5211211.....68 | 5616612.....70 | 5869994.....126, 154 |
| 5113222.....72 | 5211212.....68 | 5617111.....68 | 5869995.....126, 154 |
| 5113225.....72 | 5211215.....68 | 5617112.....68 | 5869996.....126, 154 |
| 5113231.....71 | 5315753.....69 | 5617115.....68 | 5869997.....126, 154 |
| 5113232.....71 | 5315763.....69 | 5617131.....71 | 5871000.....168 |
| 5113235.....71 | 5317753.....69 | 5617132.....71 | 5874500.....124 |
| 5113411.....69 | 5317763.....69 | 5617135.....71 | 5874504.....124 |
| 5113412.....69 | 5420118.....69 | 5617211.....68 | 5874505.....124 |
| 5113415.....69 | 5420218.....69 | 5617212.....68 | 5874799.....123 |
| 5115111.....68 | 5430118.....69 | 5617215.....68 | 5874800.....123 |
| 5115112.....68 | 5430218.....69 | 5617231.....71 | 5875501.....122 |
| 5115115.....68 | 5436118.....69 | 5617232.....71 | 5875511.....122 |
| 5115211.....68 | 5436218.....69 | 5617235.....71 | 5875512.....123 |
| 5115212.....68 | 5501509.....73 | 5619111.....68 | 5875513.....122 |
| 5115215.....68 | 5501510.....73 | 5619112.....68 | 5875514.....122 |
| 5117111.....68 | 5501511.....73 | 5619115.....68 | 5875515.....122 |
| 5117112.....68 | 5502520.....73 | 5619211.....68 | 5875516.....120 |
| 5117115.....68 | 5502521.....73 | 5619212.....68 | 5875517.....120 |
| 5117211.....68 | 5502522.....73 | 5619215.....68 | 5875518.....122 |
| 5117212.....68 | 5612610.....70 | 5711006.....130 | 5875521.....122 |
| 5117215.....68 | 5612612.....70 | 5711016.....130 | 5875522.....122 |
| 5209111.....68 | 5613111.....68 | 5711026.....130 | 5875523.....123 |
| 5209112.....68 | 5613112.....68 | 5711116.....130 | 5875527.....120 |
| 5209115.....68 | 5613115.....68 | 5711216.....130 | 5875528.....122 |
| 5209121.....72 | 5613131.....71 | 5712005.....130 | 5875550.....121 |
| 5209122.....72 | 5613132.....71 | 5712017.....130 | 5875552.....120 |
| 5209125.....72 | 5613135.....71 | 5750013.....122 | 5875553.....120 |
| 5209131.....71 | 5613211.....68 | 5751001.....122 | 5875554.....120 |
| 5209132.....71 | 5613212.....68 | 5751002.....122 | 5875555.....120 |
| 5209135.....71 | 5613215.....68 | 5751003.....122 | 5875556.....120 |
| 5209211.....68 | 5613231.....71 | 5751022.....122 | 5875557.....120 |



Index By Item Number

| | | | | | | | |
|--------------|--------------|--------------|-----|--------------|--------------------|--------------|------------------|
| 5875558..... | 120 | 5969251..... | 151 | 5980033..... | 15 | 6111062..... | 92 |
| 5875559..... | 120 | 5969254..... | 151 | 5980034..... | 15 | 6111064..... | 90 |
| 5875560..... | 121 | 5969261..... | 151 | 5980035..... | 15 | 6111067..... | 92 |
| 5875561..... | 120 | 5969264..... | 151 | 5980036..... | 15 | 6111069..... | 93 |
| 5875612..... | 123 | 5969271..... | 151 | 5980037..... | 15 | 6111071..... | 92 |
| 5880395..... | 10 | 5969274..... | 151 | 5999901..... | 107, 108, 109, 116 | 6111072..... | 93 |
| 5910001..... | 10 | 5969281..... | 151 | 5999902..... | 80, 109 | 6111137..... | 91 |
| 5910011..... | 15 | 5969284..... | 151 | 5999941..... | 107, 108, 112 | 6111162..... | 92 |
| 5910088..... | 16, 151, 173 | 5970701..... | 81 | 5999942..... | 112 | 6120009..... | 105, 107, 108 |
| 5910089..... | 16, 151, 173 | 5970703..... | 81 | 5999943..... | 112 | 6120067..... | 105 |
| 5910090..... | 16, 151, 173 | 5970705..... | 81 | 5999944..... | 112 | 6120068..... | 105 |
| 5910091..... | 16, 151, 173 | 5970707..... | 81 | 5999945..... | 112 | 6120069..... | 105 |
| 5910092..... | 16, 151, 173 | 5970708..... | 81 | 5999946..... | 112 | 6120109..... | 104, 110 |
| 5910093..... | 16, 151, 173 | 5970709..... | 81 | 5999947..... | 112 | 6120168..... | 105, 110 |
| 5910094..... | 16, 151, 173 | 5970710..... | 81 | 5999948..... | 112 | 6121009..... | 105 |
| 5910095..... | 16, 151, 173 | 5970711..... | 81 | 5999949..... | 112 | 6121067..... | 105 |
| 5910096..... | 16, 151, 173 | 5980001..... | 14 | 5999950..... | 112 | 6121109..... | 104 |
| 5910097..... | 16, 151, 173 | 5980002..... | 14 | 5999960..... | 116 | 6130007..... | 94, 109 |
| 5910098..... | 16, 151, 173 | 5980003..... | 14 | 6050735..... | 157, 171 | 6130008..... | 94 |
| 5950001..... | 8 | 5980004..... | 14 | 6057730..... | 81, 87 | 6130011..... | 80, 95, 109 |
| 5950002..... | 8 | 5980005..... | 14 | 6057737..... | 87 | 6130012..... | 80, 96, 109 |
| 5950003..... | 8 | 5980006..... | 14 | 6057738..... | 87 | 6130013..... | 80, 95, 109 |
| 5950004..... | 8 | 5980007..... | 14 | 6057739..... | 81, 87 | 6130014..... | 80, 96 |
| 5969100..... | 151 | 5980008..... | 14 | 6109902..... | 111 | 6130108..... | 94, 110 |
| 5969111..... | 151 | 5980009..... | 14 | 6109904..... | 111 | 6130113..... | 95, 110 |
| 5969114..... | 151 | 5980010..... | 14 | 6109905..... | 111 | 6130313..... | 80, 95 |
| 5969121..... | 151 | 5980011..... | 14 | 6110020..... | 99 | 6131007..... | 94 |
| 5969124..... | 151 | 5980012..... | 14 | 6110021..... | 94 | 6131013..... | 95 |
| 5969131..... | 151 | 5980013..... | 14 | 6110022..... | 88, 99 | 6131113..... | 95 |
| 5969134..... | 151 | 5980014..... | 14 | 6110029..... | 90 | 6140014..... | 98 |
| 5969141..... | 151 | 5980015..... | 14 | 6110037..... | 91 | 6140016..... | 72, 98, 107, 108 |
| 5969144..... | 151 | 5980016..... | 14 | 6110041..... | 91 | 6140046..... | 98 |
| 5969151..... | 151 | 5980017..... | 15 | 6110044..... | 93 | 6140048..... | 72, 98 |
| 5969154..... | 151 | 5980018..... | 15 | 6110045..... | 90 | 6150024..... | 100 |
| 5969161..... | 151 | 5980019..... | 15 | 6110047..... | 90 | 6150025..... | 101 |
| 5969164..... | 151 | 5980020..... | 15 | 6110062..... | 92, 107, 108 | 6150026..... | 100, 107, 108 |
| 5969171..... | 151 | 5980021..... | 15 | 6110064..... | 90, 107, 108 | 6150028..... | 101 |
| 5969174..... | 151 | 5980022..... | 15 | 6110065..... | 91, 108 | 6150091..... | 101 |
| 5969181..... | 151 | 5980023..... | 15 | 6110067..... | 92 | 6150092..... | 102 |
| 5969184..... | 151 | 5980024..... | 15 | 6110069..... | 93 | 6150093..... | 103 |
| 5969211..... | 151 | 5980025..... | 15 | 6110071..... | 92 | 6150094..... | 103, 109 |
| 5969214..... | 151 | 5980026..... | 8 | 6110072..... | 93 | 6150095..... | 103 |
| 5969221..... | 151 | 5980027..... | 8 | 6110137..... | 91, 110 | 6150096..... | 104 |
| 5969224..... | 151 | 5980028..... | 8 | 6110162..... | 92, 110 | 6150098..... | 104 |
| 5969231..... | 151 | 5980029..... | 8 | 6110169..... | 93, 110 | 6150191..... | 101, 110 |
| 5969234..... | 151 | 5980030..... | 8 | 6111037..... | 91 | 6150192..... | 102, 110 |
| 5969241..... | 151 | 5980031..... | 15 | 6111044..... | 94 | 6150194..... | 103, 110 |
| 5969244..... | 151 | 5980032..... | 15 | 6111045..... | 90 | 6150294..... | 102 |

EXAM SUPPLIES

CLEANERS & CLOTHS

ACCESSORIES

SUN LENSES

FRAME PARTS

TOOLS

MACHINES

FINISHING

SURFACING

INDEX



Index By Item Number

| | | | | | | | |
|--------------|---------------|--------------|----------|--------------|-----------------|--------------|---------------|
| 6150394..... | 102, 107, 108 | 6215210..... | 116 | 6411522..... | 86 | 6641100..... | 89 |
| 6160001..... | 97, 106 | 6215211..... | 116 | 6422014..... | 86 | 6642106..... | 9, 89 |
| 6160002..... | 97, 106 | 6216096..... | 113 | 6440020..... | 88 | 6646739..... | 152 |
| 6160003..... | 97, 106 | 6216097..... | 113 | 6440023..... | 88 | 6648770..... | 9, 120 |
| 6160004..... | 97, 106 | 6216098..... | 113 | 6440025..... | 88 | 6648774..... | 9, 120 |
| 6160005..... | 96, 106 | 6216099..... | 113 | 6450022..... | 88 | 6649022..... | 89, 108 |
| 6160006..... | 96, 106 | 6216100..... | 116 | 6450028..... | 88 | 6649023..... | 89 |
| 6160007..... | 106 | 6216111..... | 116 | 6460020..... | 88 | 6677100..... | 89 |
| 6161003..... | 97 | 6216114..... | 116 | 6470015..... | 88 | 6706021..... | 161 |
| 6161004..... | 97 | 6217101..... | 112, 168 | 6470020..... | 88 | 6706022..... | 161 |
| 6170054..... | 100 | 6217102..... | 112, 168 | 6470125..... | 88 | 6706024..... | 161 |
| 6170055..... | 99 | 6217103..... | 112, 168 | 6480000..... | 107, 108, 116 | 6706026..... | 161 |
| 6170060..... | 99 | 6218001..... | 80 | 6490000..... | 116 | 6710436..... | 160 |
| 6170061..... | 100 | 6218002..... | 80 | 6491020..... | 86 | 6710442..... | 160 |
| 6210048..... | 72, 107, 108 | 6277018..... | 116 | 6491023..... | 86 | 6710450..... | 160 |
| 6210049..... | 72 | 6277040..... | 80 | 6492020..... | 86 | 6711515..... | 86 |
| 6214600..... | 10 | 6277099..... | 114 | 6492024..... | 86 | 6711522..... | 86 |
| 6214750..... | 116 | 6278100..... | 114 | 6495022..... | 88 | 6720450..... | 160 |
| 6214752..... | 34 | 6278144..... | 114 | 6495025..... | 88 | 6720660..... | 160 |
| 6214753..... | 34 | 6278147..... | 114 | 6495028..... | 88 | 6721525..... | 86 |
| 6214754..... | 34 | 6278152..... | 114 | 6511515..... | 86 | 6730401..... | 160 |
| 6215009..... | 116 | 6278153..... | 114 | 6511522..... | 86 | 6730475..... | 160 |
| 6215012..... | 111 | 6278154..... | 114 | 6522014..... | 86 | 6730625..... | 160 |
| 6215018..... | 111 | 6278155..... | 114 | 6532225..... | 86 | 6731625..... | 160 |
| 6215090..... | 111 | 6278156..... | 114 | 6540020..... | 88 | 6732225..... | 86 |
| 6215120..... | 116 | 6278158..... | 114 | 6540023..... | 88 | 6740325..... | 122 |
| 6215121..... | 116 | 6278160..... | 114 | 6540025..... | 88 | 6740330..... | 160 |
| 6215122..... | 116 | 6278161..... | 114 | 6550022..... | 88 | 6740430..... | 160 |
| 6215123..... | 113 | 6278164..... | 114 | 6550028..... | 88 | 6750440..... | 160 |
| 6215124..... | 113 | 6279001..... | 114 | 6560020..... | 88 | 6750545..... | 160 |
| 6215125..... | 113 | 6279009..... | 114 | 6570015..... | 88 | 6750650..... | 160 |
| 6215126..... | 109, 116 | 6279012..... | 114 | 6570020..... | 88 | 6763506..... | 160 |
| 6215127..... | 111 | 6279013..... | 114 | 6570125..... | 88 | 6763565..... | 160 |
| 6215130..... | 113 | 6279014..... | 114 | 6611515..... | 86 | 6811522..... | 86 |
| 6215131..... | 113 | 6279016..... | 114 | 6611522..... | 86, 107, 108 | 6832225..... | 86 |
| 6215132..... | 113 | 6300003..... | 110 | 6615001..... | 9, 89, 107, 108 | 6911522..... | 86 |
| 6215133..... | 113 | 6300004..... | 87 | 6615003..... | 9, 89 | 6932225..... | 86 |
| 6215134..... | 113 | 6300005..... | 109 | 6615013..... | 9, 89 | 7011001..... | 137 |
| 6215135..... | 113 | 6300006..... | 88 | 6615103..... | 9, 89 | 7021XXX..... | 132, 133, 136 |
| 6215136..... | 113 | 6300010..... | 87 | 6615203..... | 9, 89 | 7022XXX..... | 132, 133, 136 |
| 6215137..... | 113 | 6300015..... | 108 | 6621205..... | 9, 89 | 7023112..... | 137 |
| 6215138..... | 113 | 6300017..... | 107 | 6621525..... | 86, 107, 108 | 7023121..... | 137 |
| 6215139..... | 113 | 6300025..... | 87 | 6622005..... | 9, 89 | 7023132..... | 137 |
| 6215141..... | 113 | 6300211..... | 87 | 6632225..... | 86 | 7023171..... | 137 |
| 6215145..... | 88, 108 | 6370000..... | 88 | 6633307..... | 89, 108 | 7023231..... | 137 |
| 6215146..... | 88 | 6391000..... | 86 | 6635175..... | 81 | 7023311..... | 137 |
| 6215148..... | 113 | 6394400..... | 88 | 6640307..... | 173 | 7023341..... | 137 |
| 6215149..... | 87 | 6411515..... | 86 | 6641000..... | 89 | 7023361..... | 137 |



Index By Item Number

| | | | | | | | |
|--------------|---------------|--------------|----------|--------------|-----|--------------|-----|
| 7023707..... | 137 | 7050213..... | 141 | 7091034..... | 148 | 7095035..... | 146 |
| 7023708..... | 137 | 7050223..... | 141 | 7091035..... | 148 | 7095036..... | 146 |
| 7024XXX..... | 132, 133, 134 | 7050623..... | 141 | 7091036..... | 148 | 7095037..... | 146 |
| 7026XXX..... | 132, 133, 135 | 7050926..... | 147, 150 | 7091116..... | 146 | 7095038..... | 146 |
| 7027XXX..... | 132, 133, 134 | 7051719..... | 141 | 7091118..... | 146 | 7095058..... | 147 |
| 7028XXX..... | 132, 133, 135 | 7051725..... | 141 | 7091218..... | 146 | 7095116..... | 146 |
| 7029XXX..... | 132, 133, 136 | 7054213..... | 140 | 7091318..... | 146 | 7095212..... | 146 |
| 7031001..... | 138 | 7054215..... | 140 | 7092015..... | 147 | 7095218..... | 146 |
| 7031004..... | 138 | 7055613..... | 140 | 7092022..... | 147 | 7095238..... | 147 |
| 7031085..... | 143 | 7055623..... | 140 | 7092025..... | 147 | 7095312..... | 147 |
| 7031112..... | 138 | 7055633..... | 140 | 7092032..... | 147 | 7095318..... | 146 |
| 7031311..... | 143 | 7059613..... | 140 | 7092115..... | 147 | 7095338..... | 146 |
| 7031351..... | 143 | 7059623..... | 140 | 7092212..... | 147 | 7095452..... | 146 |
| 7031402..... | 143 | 7059625..... | 140 | 7092302..... | 147 | 7096000..... | 148 |
| 7031411..... | 143 | 7059626..... | 141 | 7092312..... | 147 | 7096001..... | 148 |
| 7031705..... | 138 | 7059627..... | 141 | 7092331..... | 147 | 7096002..... | 148 |
| 7031712..... | 137 | 7063613..... | 140 | 7092332..... | 147 | 7096003..... | 148 |
| 7032311..... | 143 | 7063623..... | 140 | 7092415..... | 147 | 7096004..... | 148 |
| 7032351..... | 143 | 7080411..... | 140 | 7093017..... | 149 | 7096005..... | 148 |
| 7033841..... | 139 | 7080611..... | 140 | 7093027..... | 149 | 7096008..... | 147 |
| 7033842..... | 139 | 7080613..... | 140 | 7093117..... | 148 | 7096009..... | 147 |
| 7040411..... | 140 | 7080623..... | 140 | 7093212..... | 148 | 7096010..... | 147 |
| 7040421..... | 140 | 7081613..... | 141 | 7093217..... | 148 | 7096011..... | 147 |
| 7040611..... | 140 | 7081623..... | 141 | 7093227..... | 148 | 7096020..... | 149 |
| 7040613..... | 141 | 7081633..... | 141 | 7093232..... | 149 | 7096021..... | 149 |
| 7040615..... | 141 | 7081717..... | 141 | 7093237..... | 149 | 7096022..... | 149 |
| 7040621..... | 140 | 7081718..... | 141 | 7093310..... | 149 | 7096023..... | 149 |
| 7040623..... | 141 | 7087125..... | 141 | 7093311..... | 149 | 7096024..... | 149 |
| 7040811..... | 141 | 7090001..... | 141 | 7093312..... | 148 | 7096026..... | 149 |
| 7040821..... | 140 | 7090640..... | 170 | 7093313..... | 149 | 7096027..... | 149 |
| 7043411..... | 140 | 7090641..... | 170 | 7093314..... | 149 | 7096028..... | 149 |
| 7043611..... | 140 | 7090642..... | 170 | 7093315..... | 148 | 7096029..... | 149 |
| 7043613..... | 141 | 7090643..... | 170 | 7093317..... | 148 | 7096030..... | 149 |
| 7043615..... | 141 | 7090644..... | 170 | 7093333..... | 148 | 7096031..... | 149 |
| 7043621..... | 140 | 7091007..... | 146 | 7093334..... | 149 | 7096033..... | 170 |
| 7043623..... | 141 | 7091008..... | 146 | 7093337..... | 148 | 7096034..... | 170 |
| 7043811..... | 140 | 7091009..... | 146 | 7093338..... | 149 | 7096035..... | 170 |
| 7043821..... | 140 | 7091010..... | 146 | 7093339..... | 149 | 7096036..... | 170 |
| 7046616..... | 141 | 7091011..... | 146 | 7095025..... | 147 | 7096037..... | 170 |
| 7048411..... | 140 | 7091012..... | 146 | 7095026..... | 147 | 7097042..... | 144 |
| 7048421..... | 140 | 7091013..... | 146 | 7095027..... | 147 | 7097043..... | 144 |
| 7048611..... | 140 | 7091014..... | 146 | 7095028..... | 147 | 7097044..... | 144 |
| 7048613..... | 141 | 7091015..... | 146 | 7095029..... | 147 | 7097045..... | 144 |
| 7048615..... | 141 | 7091025..... | 148 | 7095030..... | 147 | 7097061..... | 144 |
| 7048621..... | 140 | 7091030..... | 148 | 7095031..... | 147 | 7097062..... | 144 |
| 7048623..... | 141 | 7091031..... | 148 | 7095032..... | 147 | 7097063..... | 144 |
| 7048811..... | 141 | 7091032..... | 148 | 7095033..... | 146 | 7097065..... | 144 |
| 7048821..... | 140 | 7091033..... | 148 | 7095034..... | 146 | 7097444..... | 144 |

Index By Item Number

| | | | | | | | |
|--------------|-----|--------------|----------|--------------|----|--------------|-----|
| 7098410..... | 148 | 7220110..... | 8 | 7703262..... | 64 | 7866291..... | 61 |
| 7098411..... | 148 | 7245501..... | 78 | 7703271..... | 64 | 7866292..... | 61 |
| 7098412..... | 148 | 7248551..... | 78 | 7703273..... | 64 | 7866300..... | 63 |
| 7098413..... | 148 | 7248561..... | 78 | 7703274..... | 64 | 8010011..... | 128 |
| 7098414..... | 148 | 7250601..... | 78 | 7762261..... | 65 | 8011611..... | 128 |
| 7098415..... | 148 | 7260120..... | 78 | 7762262..... | 65 | 8011711..... | 129 |
| 7098416..... | 148 | 7270140..... | 78 | 7762271..... | 65 | 8013391..... | 128 |
| 7098418..... | 148 | 7300001..... | 142 | 7762274..... | 65 | 8020121..... | 128 |
| 7099001..... | 150 | 7300002..... | 142 | 7763100..... | 65 | 8020321..... | 129 |
| 7099002..... | 150 | 7300008..... | 142 | 7763200..... | 65 | 8020421..... | 128 |
| 7099003..... | 150 | 7310008..... | 142, 161 | 7763261..... | 64 | 8021321..... | 128 |
| 7099004..... | 150 | 7310009..... | 142, 161 | 7763271..... | 64 | 8023511..... | 129 |
| 7099005..... | 150 | 7310018..... | 142, 161 | 7763274..... | 64 | 8030231..... | 128 |
| 7099006..... | 150 | 7314001..... | 120, 161 | 7764161..... | 65 | 8030331..... | 128 |
| 7099007..... | 150 | 7314016..... | 120, 161 | 7764171..... | 65 | 8030431..... | 129 |
| 7099008..... | 150 | 7324001..... | 120, 161 | 7764174..... | 65 | 8031021..... | 128 |
| 7099009..... | 150 | 7360120..... | 78 | 7765268..... | 64 | 8031131..... | 128 |
| 7099010..... | 150 | 7360140..... | 78 | 7765278..... | 64 | 8035500..... | 129 |
| 7099011..... | 150 | 7370150..... | 78 | 7783261..... | 64 | 8041680..... | 128 |
| 7099012..... | 150 | 7371923..... | 142 | 7783271..... | 64 | 8050141..... | 128 |
| 7099013..... | 150 | 7371924..... | 142 | 7783274..... | 64 | 8060651..... | 129 |
| 7099014..... | 150 | 7371925..... | 142 | 7793261..... | 64 | 8070761..... | 128 |
| 7099015..... | 150 | 7399900..... | 142 | 7793271..... | 64 | 8071561..... | 128 |
| 7099016..... | 150 | 7399901..... | 142 | 7793274..... | 64 | 8074900..... | 129 |
| 7099017..... | 150 | 7399902..... | 142 | 7862161..... | 61 | 8080871..... | 128 |
| 7099018..... | 150 | 7399903..... | 142 | 7862174..... | 61 | 8080971..... | 129 |
| 7099019..... | 150 | 7399904..... | 142 | 7862181..... | 61 | 8090381..... | 129 |
| 7099020..... | 150 | 7399905..... | 142 | 7863361..... | 61 | 8091157..... | 128 |
| 7099021..... | 150 | 7399906..... | 142 | 7863371..... | 61 | 8092081..... | 129 |
| 7099022..... | 150 | 7399907..... | 142 | 7863374..... | 61 | 8092510..... | 129 |
| 7099023..... | 150 | 7399908..... | 142 | 7864261..... | 61 | 8210003..... | 115 |
| 7099024..... | 150 | 7399909..... | 142 | 7864271..... | 61 | 8211000..... | 115 |
| 7099025..... | 150 | 7399910..... | 142 | 7864273..... | 61 | 8211002..... | 115 |
| 7099026..... | 150 | 7399911..... | 142 | 7864274..... | 61 | 8215301..... | 115 |
| 7099027..... | 150 | 7399920..... | 142 | 7865244..... | 62 | 8215303..... | 115 |
| 7099028..... | 150 | 7480651..... | 144 | 7865255..... | 62 | 8216448..... | 115 |
| 7099029..... | 150 | 7480655..... | 144 | 7865261..... | 62 | 8224112..... | 115 |
| 7099030..... | 150 | 7700000..... | 152 | 7865266..... | 62 | 8244205..... | 115 |
| 7099032..... | 150 | 7701100..... | 65 | 7865268..... | 62 | 8244601..... | 115 |
| 7099034..... | 150 | 7701101..... | 65 | 7865271..... | 62 | 8245105..... | 115 |
| 7099037..... | 149 | 7702160..... | 65 | 7865274..... | 62 | 8245303..... | 115 |
| 7099038..... | 149 | 7702161..... | 65 | 7865277..... | 62 | 9210506..... | 81 |
| 7099039..... | 149 | 7702171..... | 65 | 7865278..... | 62 | 9210518..... | 81 |
| 7200050..... | 78 | 7702174..... | 65 | 7865288..... | 62 | 9210524..... | 81 |
| 7210404..... | 144 | 7703161..... | 64 | 7866251..... | 62 | 9210702..... | 81 |
| 7210406..... | 144 | 7703171..... | 64 | 7866252..... | 62 | 9999998..... | 51 |
| 7220108..... | 161 | 7703174..... | 64 | 7866281..... | 62 | | |
| 7220109..... | 161 | 7703261..... | 64 | 7866282..... | 62 | | |



METALLIC INKS



Silver and Gold
Metallic Printing
For Your Personalized Imprints

More product information on pages 27-31

TERMS AND CONDITIONS

The following terms and conditions apply to all services and to all merchandise (referred to as the "Goods") purchased from Dynamic Laboratories, Inc. ("Seller"). The party purchasing the services or Goods from Seller is referred to as the "Buyer."

1. **PRICE.** All prices in this catalogue are listed in U.S. Dollars (\$USD). The Goods and any other items or services provided by Seller shall be sold and Invoiced at Seller's prices and charges in effect at the time of each shipment of Goods. Seller reserves the right to change without notice the published list prices referenced in this catalogue, on any sales order, or on Seller's website. Such prices do not include sales, excise, use or other taxes (other than taxes based on income) now in effect or hereafter levied by reason of this transaction. Buyer shall pay all such taxes.

2. **PAYMENT TERMS.** Seller, at its sole and absolute discretion, may elect to extend, limit or revoke credit terms to Buyer. Where credit is extended by Seller, payment terms are [net 30] days from the date of the invoice. Seller reserves the right to require alternative payment terms and shall not be obligated to extend credit to any Buyer. Buyer shall be liable for the price of all products substantially conforming to the contract, notwithstanding that Buyer may not have accepted, or may have revoked acceptance of same. Buyer shall be deemed to have accepted the accuracy and content of all invoices unless Buyer notifies Seller, in writing, of any discrepancies on or before the due date.

3. **LATE PAYMENTS.** If payment is not received by the due date, a service charge will be added at the rate of 1 1/2 percent per month (18% per year) or the maximum legal rate, whichever is less, to unpaid Invoices from the due date thereof.

4. **MULTIPLE SHIPMENTS.** Seller may make delivery in installments and may render a separate invoice for each installment, which invoice shall be paid when due, without regard to subsequent deliveries. Each installment shall be deemed a separate sale. Delay in delivery of any installment shall not relieve Buyer of its obligation to accept delivery of remaining installments. Any delivery not in dispute shall be paid for on the due date, as provided in this contract, without offset, defense or counterclaim and regardless of controversies relating to other delivery or undelivered products.

5. **ACCEPTANCE.** Buyer agrees to accept any tender of the Goods by Seller which substantially conforms to the description of the Goods set forth herein, or in and sales order or contract. Buyer shall be deemed to have accepted any Goods and Buyer's right to cancel, reject or claim any damages for breach of warranty or breach of Seller's obligations in connection with the sale of the Goods shall terminate unless Buyer gives Seller notice in writing of Seller's breach in the case of defects discoverable through inspection, 30 (thirty) days after delivery of the Goods or in the case of defects not discoverable through inspection, 30 (thirty) days after invoice date. Acceptance of any non-conforming Goods shall constitute a waiver by Buyer of specification requirements for said Goods. Buyer's acceptance of Goods tendered under this contract shall be final and irrevocable.

6. **DELIVERY.** Delivery of the Goods shall be F.O.B. Seller's shipping point. Seller shall make reasonable efforts to ship Goods and perform services in a timely manner. Seller, however, shall not be responsible for the delay in any shipment or delivery of Goods or services which are not within the control of Seller. **IN NO EVENT SHALL SELLER, IN THE EVENT OF DELAYS, NONPERFORMANCE, OR OTHERWISE, BE LIABLE TO BUYER OR ANY THIRD PARTIES FOR ANY CONSEQUENTIAL, SPECIAL, OR CONTINGENT DAMAGES.** In the event of any delay or failure of performance, Seller shall have such additional time to perform its obligations hereunder as may reasonably be necessary under the circumstances. If Seller is unable to perform this contract in whole or in part, then to the extent that it is unable to perform, any contract for Goods or services shall be deemed terminated without liability to either party, but shall remain in effect as to any unaffected portion of the contract.

7. **LIMITATION OF SELLER'S LIABILITY.** If Buyer timely notifies Seller in writing of a claimed defect in accordance with the terms set forth herein, Buyer shall concurrently offer Seller the opportunity to investigate the claim and to inspect allegedly defective Goods. If Seller determines that Buyer's claim is valid, Seller may repair the defective Goods or replace the defective Goods with conforming Goods. Failure to offer Seller opportunity to inspect the Goods shall constitute acceptance by Buyer and waiver of all claims for defects. **SELLER'S LIABILITY FOR DAMAGES ON ACCOUNT OF A CLAIMED DEFECT IN ANY PRODUCT DELIVERED BY SELLER SHALL IN NO EVENT EXCEED THE PURCHASE PRICE OF THE PRODUCT ON WHICH THE CLAIM IS BASED.** Replacement of defective Goods or at Seller's discretion, repayment of the purchase price for any such Goods will be made only upon return of the defective Goods. Specifically and without limiting the generality of the foregoing, **SELLER SHALL NOT BE RESPONSIBLE OR LIABLE TO BUYER OR TO ANY THIRD PARTY FOR ANY LOST PROFITS, OR INCIDENTAL,**

CONSEQUENTIAL, INDIRECT, SPECIAL OR CONTINGENT DAMAGES FOR ANY BREACH OF WARRANTY OR OTHER BREACH OF SELLER'S OBLIGATIONS UNDER THIS OR ANY CONTRACT FOR THE SALE OF GOODS OR SERVICES. SELLER SHALL NOT BE LIABLE FOR DAMAGES RELATING TO ANY INSTRUMENT, EQUIPMENT, OR APPARATUS WITH WHICH THE PRODUCT SOLD UNDER THIS CONTRACT IS USED.

8. **SELLER'S REMEDIES.** If Buyer fails, with or without cause, to furnish Seller with specifications and/or instructions for, or refuses to accept deliveries of any products sold under this contract, or is otherwise in default under or repudiates this contract or any other contract with Seller, or fails to pay when due any invoice under due to Seller, then in addition to any and all remedies allowed by law, Seller without notice may defer shipment under this or any other contract between Buyer and Seller until such default, breach or repudiation is removed and/or (c) may cancel any undelivered portion of this and/or any other contract in whole or in part (Buyer remaining liable for damages).

9. **SPECIFICATIONS AND MODELS.** Any description of the Goods contained in any sales order or contract, or any sample or model used or referred to shall be for the sole purpose of identifying the Goods, and any such description shall not constitute a warranty that the Goods conform thereto.

10. **DISCLAIMER OF WARRANTY.** SELLER SPECIFICALLY EXCLUDES ALL EXPRESS AND IMPLIED WARRANTIES, INCLUDING, WITHOUT LIMITATION ANY WARRANTY THAT THE GOODS SOLD UNDER THIS AGREEMENT ARE MERCHANTABILITY OR ARE FIT FOR ANY PARTICULAR PURPOSE.

11. **NO ADDITIONAL TERMS.** Agents and salesmen of Seller have no authority to make any representations not included herein or to alter any of the terms or conditions contained herein, or to accept any terms not contained herein. Seller hereby rejects any different or additional terms proposed by Buyer or included in Buyer's purchase order or any other document, none of which shall be effective unless set forth in a writing signed by the President or Vice President of Seller.

12. **NO ORAL MODIFICATIONS.** The foregoing terms and conditions may not be modified orally or by the conduct of any party.

13. **JURISDICTION AND GOVERNING LAW.** This agreement, and all sales of Goods or services by Seller to Buyer shall be governed by and construed in accordance with the internal laws of the State of New York, without regard to choice of law or conflicts of law principles. Buyer hereby agrees to submit to the exclusive personal jurisdiction of the Courts of the State of New York in connection with any dispute arising out of this agreement or the sales or services provided by Seller to Buyer, with venue of any such action in the appropriate state or federal courts situated in either Nassau or Suffolk County.

14. **SEVERABILITY.** In the event that any provision of the foregoing terms and conditions is found to be illegal or unenforceable by any court or tribunal of competent jurisdiction, that provision or term shall be stricken entirely by such court or tribunal and the remainder of this agreement between Buyer and Seller shall remain binding on the parties.

15. **NO WAIVER.** If Seller fails to, or elects not to enforce any right or remedy to which it may be entitled hereunder or by law, such right or remedy shall not be waived, nor shall such non-action be construed to confer a waiver as to any continued or future acts, nor shall any other right or remedy be waived as a result thereof.

16. **ATTORNEYS' FEES.** In addition to all other remedies and damages available, in the event of any litigation arising out of Buyer's failure to pay any amount due hereunder, Seller shall be entitled to recover from Buyer all of its reasonable expenses and disbursements incurred in the collection of such amount, whether by judgment or settlement, or in the enforcement or collection of any judgment or award rendered therein including, without limitation, costs of investigation and reasonable attorneys' fees.

17. **CAPTIONS.** The captions appearing herein are for convenience only, and shall have no effect the construction or interpretation of the terms and conditions set forth above.

SPECIAL ORDERS FOR ITEMS NOT IN OUR CATALOG WILL BE SUBJECT TO A \$50 MINIMUM. SURCHARGES MAY APPLY.

Exam
Supplies

Cleaners
& Cloths

Accessories

Sun Lenses

Frame Parts

Tools

Machines

Finishing

Surfacing



Manufacturing & Distributing Optical Supplies Since 1996

888-339-6264 ■ Intl. 631-231-7474 ■ dynamiclabs.net



30 Haynes Court, Ronkonkoma, NY 11779